

METAL INDUSTRY WIRE / BRIGHT STEEL

Comprehensive quality inspection in the manufacturing process.

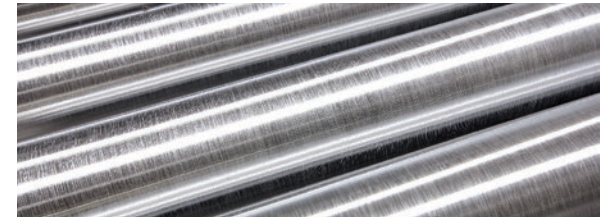

Production processes	4 – 5
Testing in the rolling process	6 – 7
Testing bright steel	8 – 11
Coil to coil drawing and profile wires	12 – 15
Wire thinner than 5 mm	16 – 19
Wire made from non-ferrous metals	20 – 23
Special applications	24 – 27
Technology	28 – 29
System provider	30 – 31
Solution provider	32 – 33
Worldwide	34 – 35

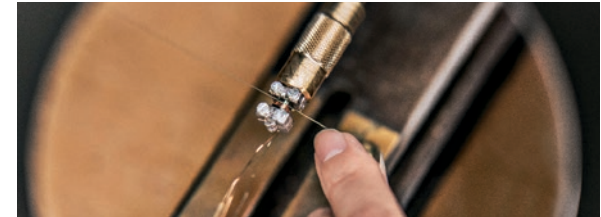

FOERSTER – Your expert for non-destructive testing methods

Electromagnetic testing methods have long been established as a method for quality monitoring in the wire industry. Quick, non-destructive and reliable, the eddy current method can be used to assess the surface quality of material under test, as well as to monitor the quality of the test results. In many cases, conclusions can be drawn about the production process itself.

For over 70 years, FOERSTER has provided innovative testing equipment and sensors for eddy current and magnetic inductive testing, as well as measuring systems for determining magnetic properties. Today, we offer a broad portfolio of testing instruments and sensors to optimally support a wide variety of manufacturing processes and end products. Our customers worldwide rely on FOERSTER's durable and robust instruments.

Testing wire with FOERSTER

The eddy current test instruments DEFECTOMAT and CIRCOGRAPH are particularly suitable for non-contact material testing of wire and bright steel in both in- and off-line operation.

But we go above and beyond the standard applications. We have the right solution for inspection tasks with special requirements, too for example: sensor systems appropriate for material diameters starting at 0.1 mm, temperatures up to 1200 °C, and inspection speeds of up to 150 m/s. There's the DEFECTOTHERM for testing right in the rolling mill, or our sensor system specifically for fine wire. We can provide reliable quality testing at all times. Of course, we also use modern digital testing electronics to record and process the test results for easy assessment of the material quality – and comprehensive documentation thereof.

A strong promise

Our goal at FOERSTER is to find the optimal testing solution for the diverse challenges faced by our customers. This is why we offer not only individual instruments but also complete test lines, with connection either to the customer's own superordinate software or to the FOERSTER Instrumentation Software. From application consulting to design, and from design to training and service – at FOERSTER you get it all from a single source. We support you at every phase of your project, so you can concentrate on what you do best.



© Saarstahl AG

Testing of wire in production

Testing in the rolling mill

In the rolling process, it's possible to detect surface defects such as scabs, cracks or over-rolling caused by imperfect feed stock or damaged rolls. This is the purpose for which FOERSTER developed the DEFECTOTHERM sensor system: to check the wire – still glowing hot – right in the rolling mill. The test results are used to quickly intervene in the production process as needed and to optimize parameters.

Particularly in the copper wire industry, it's essential to identify any ferritic inclusions, as these can lead to breakage as the wire is being drawn. This is why FOERSTER sets the DEFECTOMAT CI, outfitted with a FERROMAT channel, directly into the rolling process line, to test the copper wire for overall quality and potential ferritic impurities even before it's wound onto the coil.

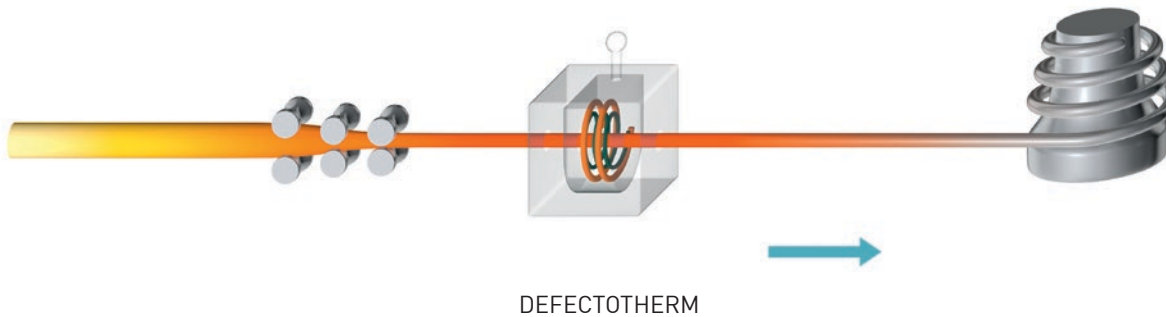

DEFECTOTHERM

Testing during the drawing process

Our rotating sensor system CIRCOGRAPH checks drawn wire for longitudinal surface defects. For a more comprehensive inspection, a DEFECTOMAT channel with an encircling test coil can be added to the unit to reliably detect transverse and point defects. This can be followed by statistical evaluation to assess the material quality of the whole wire coil. Additionally, the results provide insights into the production processes themselves, allowing them to be optimized, if necessary.

For the detection of material mix-ups and faulty tempering in bars made of bright steel, FOERSTER offers its MAGNATEST D-HZP. The bars undergo a magneto-inductive test at the end of the manufacturing process. The cumulative results of the various testing systems along the way, such as the eddy current and magneto-inductive testing, lead to a final conclusion about the overall quality of the parts, which are then sorted into 'good' and 'bad' lots right in the production flow.

On the following pages, we present you with an overview of the many test solutions and applications that we have already implemented successfully. Since each application has its own special challenges, only a broad product portfolio like ours can always offer the optimum solution.

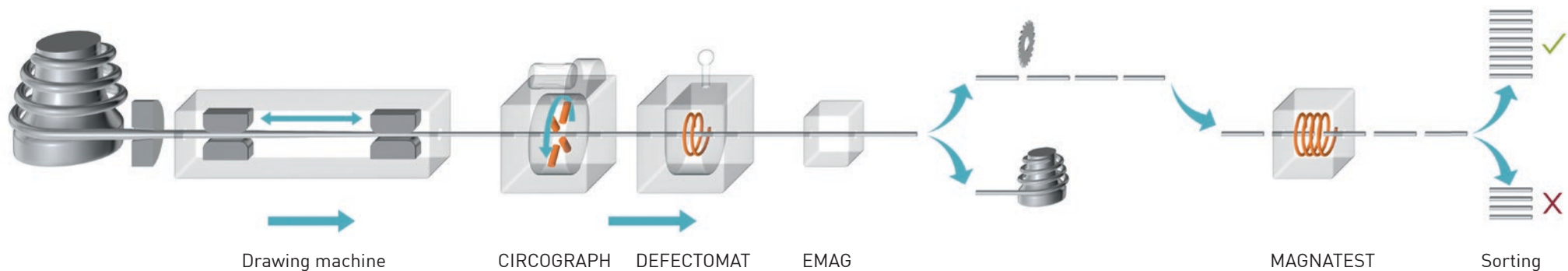

ROLLED WIRE

Testing in the rolling process

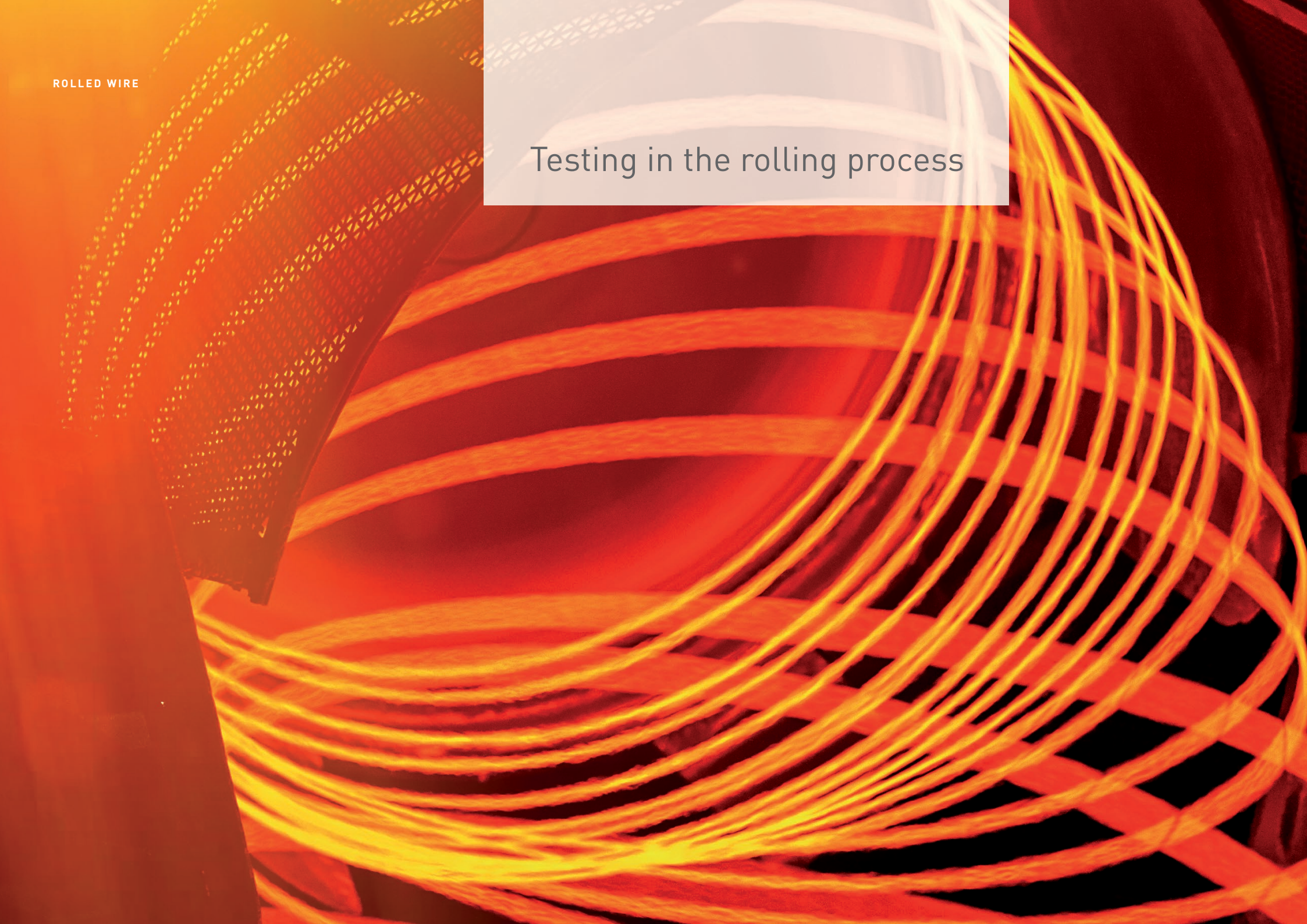

Testing in the rolling process

Testing hot rolled wire directly in the rolling mill places extraordinary demands on the test system. That's why they're designed for material temperatures of up to 1200 °C and can deliver reliable results even at testing speeds of up to 150 m/s.

The water-cooled DEFECTOTHERM test coils allow the wire to be tested directly in the rolling line because it relies on the eddy current method, which is well suited for use under extreme conditions. Material defects such as undesired roll marks, cracks or scabs are reliably detected.

The DEFECTOTHERM test coils are used in conjunction with DEFECTOMAT testing and evaluation electronics in a continuous process. Test coils are available for material diameters ranging 5 mm to 60 mm.



To assess the wire quality, statistical evaluation of the defect distribution (Section Quality Index) is carried out after the test, and an analysis of the entire wire coil (Rod Quality Index) is conducted for purposes of comprehensive process monitoring. There is also an evaluation of serious individual defects that would otherwise have gotten lost in the summary statistics.

- (1) DEFECTOMAT® DA
- (2) DEFECTOTHERM® sensor system
- (3) DEFECTOTHERM® test coil

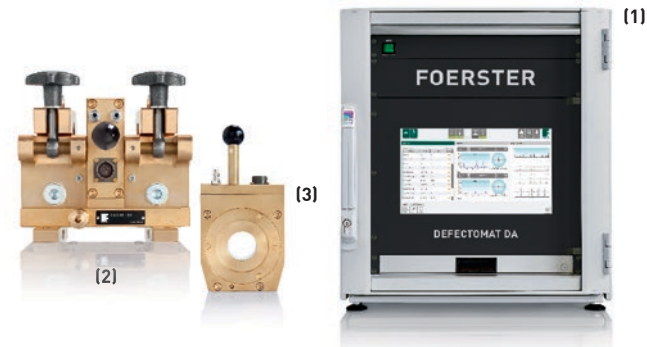

BRIGHT STEEL

Testing bright steel



High defect resolution for best product quality

Drawn or peeled bright steel serves as a raw material for many different products, including some that can have a direct effect on safety. These applications especially require impeccable quality. With FOERSTER testing equipment, you can control and visualize the quality of the material surface during the production process.

Stress cracks, scabs and chips are just a few examples of the kinds of material defects that can occur during production. Our encircling test coils and rotating sensor systems check your material for these flaws. The high defect resolution of our inspection systems allows for responsive and reliable inspection of the material, tailored to suit your requirements.

In many cases, our testing equipment can help identify repeating defect patterns, allowing irregularities to be eliminated and optimization of the overall manufacturing process.

Our instruments support you in the end-to-end monitoring of your manufacturing process – both inline and offline.

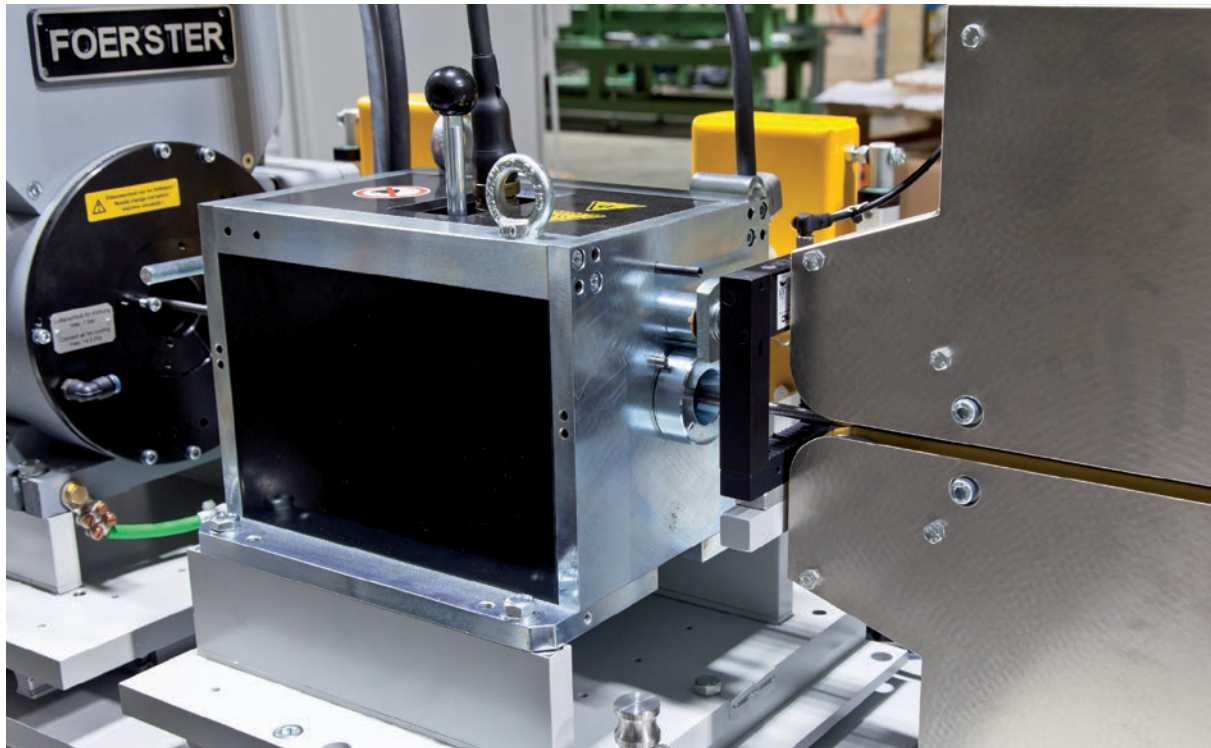

Inline testing in the drawing machine

Defects in the primary material, machine-related settings or damaged tools can cause surface defects in the end product. FOERSTER uses the CIRCOGRAPH rotating sensor system to detect these defects. By using movable sensors (test levers), the probes are protected against potential damage resulting from burrs protruding from the end of the material coil or hooked ends.

To find point and transverse defects, additional testing with a DEFECTOMAT encircling coil is recommended. DC magnetization is used to exclude the influence of permeability fluctuations. This ensures reliable testing of ferromagnetic materials. Cut-to-length bars are then sorted out or reworked on the basis of the results of the material testing.

- (1) CIRCOGRAPH® DA
- (2) Sensor system M
- (3) Encircling coil
- (4) CIRCOGRAPH® Ro 35 L

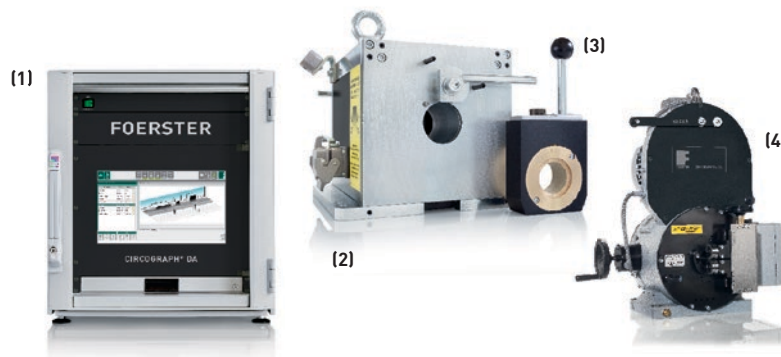



Courtesy of BGH Edelstahl Lugau GmbH

(4) MAGNATEST® D-HZP

(5) Wire test line

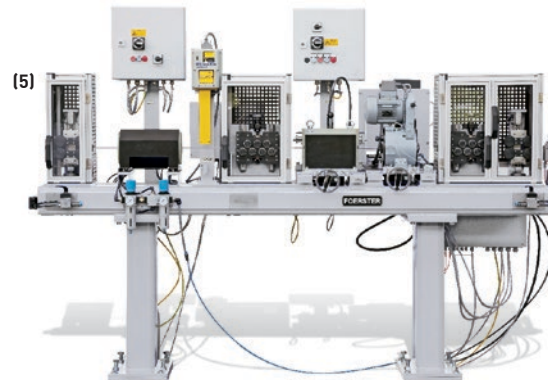

Offline test lines

Offline test lines are frequently employed in the final inspection of high-quality bright steels, which are used as input materials for safety-relevant vehicle parts, among other things. The input material is then re-tested to assess whether it meets the required specifications. Defective bars can thus be sorted out quickly and automatically.

FOERSTER offers not only individual testing instruments, but also entire guidance units and assembly of the line, including mechanics and control system. Depending on the specific customer requirements, various testing and measuring systems can be integrated into the offline test line. For example, in addition to surface defect testing, a MAGNATEST D-HZP can be integrated for hardness testing and material identification to prevent mix-ups. In addition to testing bars, the offline testing line can also be integrated into the coil-to-coil wire testing.

COIL TO COIL DRAWING AND PROFILE WIRES

Coil to coil drawing and profile wires



Reliable testing of steel wire

Due to its relatively simple handling, steel wire is used in many end products. Using the non-destructive eddy current method, FOERSTER monitors the quality of your material and brings defects to light.

As a technology leader, we are not only well versed in the inspection of round steel wire, but we also have decades of experience in the testing of complex profile wire. This can take on a wide variety of shapes, such as flat or oval, rectangular or trapezoidal, semicircular or square profiles – as well as unique, customer-specific profiles. There's also increasing demand for Z-shaped wire, which is used for flexible offshore pipelines, among other things.

With its large selection of different encircling test coils and probes, FOERSTER offers the right testing solution for your wire. For profile wire we also have form-adapted test coils available, or together we can develop individual encircling coils for high-resolution testing. Discover a few of our many solutions on the following pages.



Round steel wire

During the coil to coil drawing process, longitudinal defects can occur that are caused by defective primary materials or irregularities. In the coil-to-coil process, e.g. in a drawing line, the various FOERSTER rotating heads can reliably inspect wire starting at 2 mm in diameter for surface defects.

The results are then evaluated and documented by the test system. Furthermore, special evaluation software from FOERSTER performs statistical defect analysis for purposes of process optimization. Continuous testing enables early intervention in the manufacturing process – as soon as major changes in surface quality are detected – thus ensuring product quality.



Spring wire for chassis springs

Spring wire, which is used in the automotive industry to manufacture suspension springs, must withstand extreme stresses. Defective material can quickly lead to failure. Here, 100% inspections are indispensable – to monitor the material quality, to prevent the use of defective materials and to document the results.

The CIRCOGRAPH inspection system is used to check for cracks in the material surface. Because the sensors rotate around the material at high speed, it ensures complete coverage of the entire material surface.

- (1) CIRCOGRAPH® CI
- (2) CIRCOGRAPH® Ro 20 P
- (3) CIRCOGRAPH® Ro 35 L

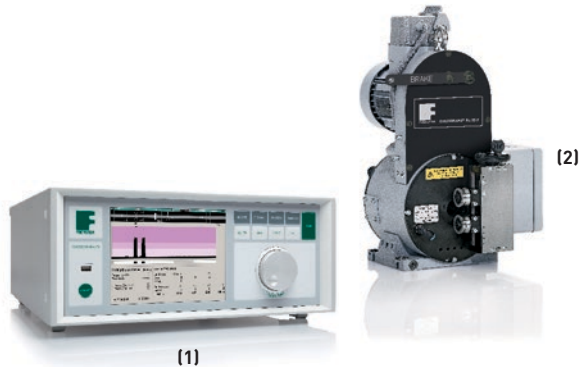

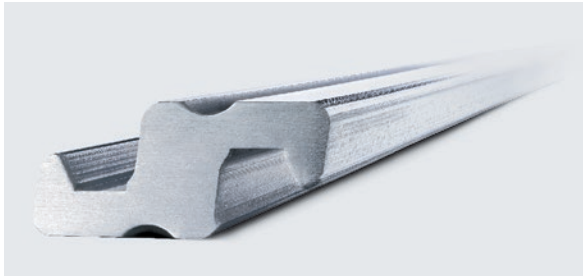

Profile wire with Z profile

An example of wires with special geometries are the Z-shaped ones used in flexible offshore pipelines. This special profile permits flexibility in the internal pipes and serves as mechanical protection against the high pressure found under water. For testing Z-shaped wires, FOERSTER has developed a special floating encircling test coil with six segments precisely adapted to this profile. The six sensors are positioned at the critical points in order to reliably detect faults.

The test electronics of the DEFECTOMAT DA allows precise localization of the defect. Furthermore, the six segments in the coil achieve a higher defect resolution. The number of sensors depends on the shape of the test material – and with the new DA generation of instruments, there are virtually no limits to the number of sensors. This allows economical testing of even the most complex shapes.



Valve spring wire

Valve springs with an oval profile can be found in modern high-performance engines. This profile imparts strength even at extreme loads, which occur at high engine speeds. This is intended to prevent valve spring failure – and, thus, a total loss.

Our equipment tests valve spring wire for both longitudinal and transverse defects. Distance compensation guarantees consistent test sensitivity even when using a rotating head to examine oval wire. It's also possible to develop shape-adapted, customer-specific encircling test coils for oval wire that can be used with DEFECTOMAT.

- (3) Hexagonal encircling test coil for profile wires
- (4) DEFECTOMAT® DA



FINE WIRE

Wire thinner than 5 mm

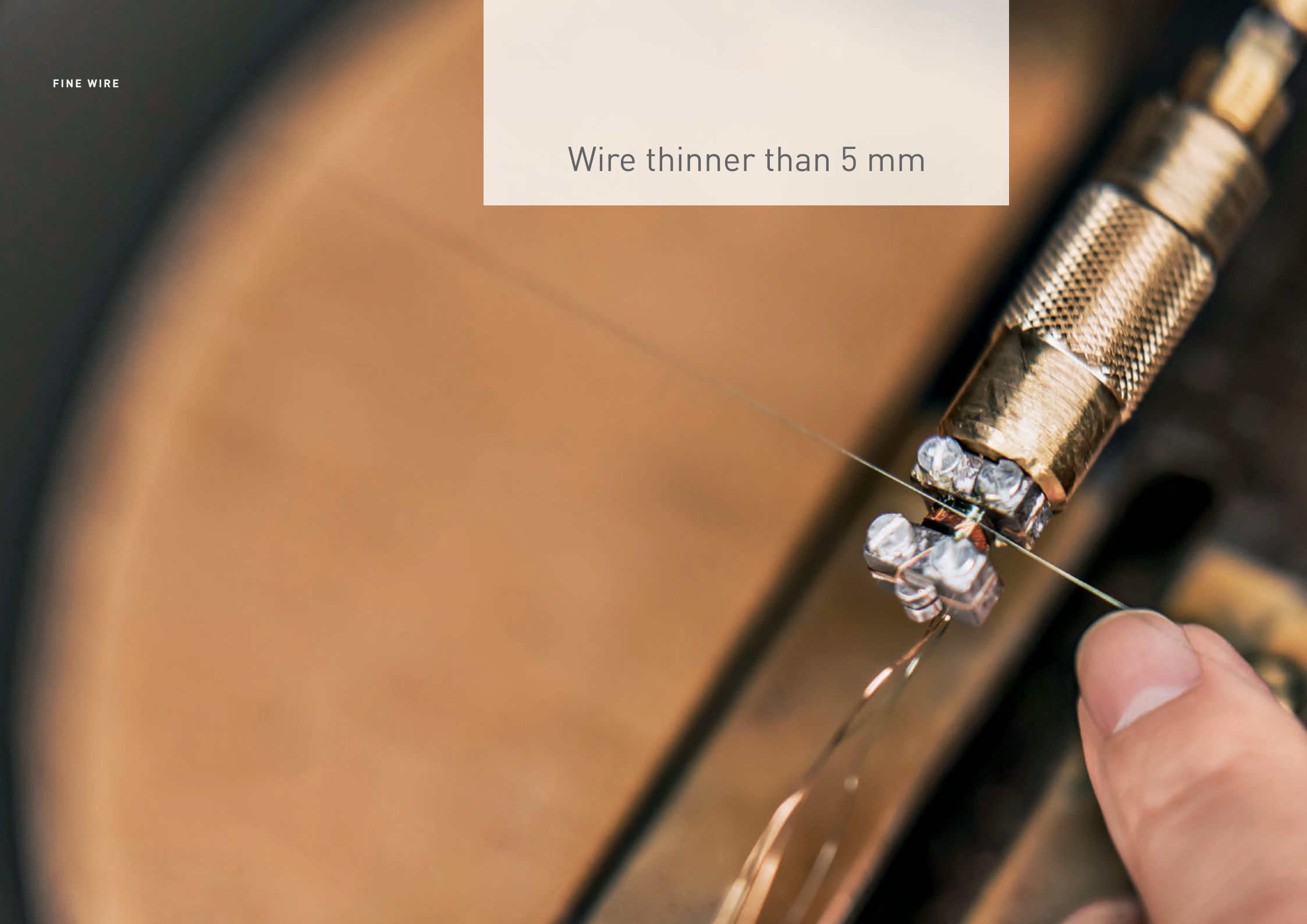

Confidently check ultra-fine wires

The manufacture of fine wires such as those required in medical technology and automotive lighting systems places special demands on the inspection system due to the small dimensions involved. For even the finest wires, FOERSTER has developed special sensor systems that reliably detect and evaluate material defects.

The DEFECTOMINI sensor system is designed specifically for thin wires and tubes with diameters between 0.3 mm and 4 mm. Optionally equipped with permanent magnets, it can test all metals, including ferritic materials.

For even thinner wires, the fine wire sensor system with special evaluation options is also available. For best results, test coils are available in minute increments for material diameters ranging from 0.1 mm to 2 mm.



Enameled wire

Enameled wire made of copper is used for the construction of electrical coils and transformers as well as in electrical drive technology. Discontinuities in the wire material can impair the enamel layer and thus the insulation. Such faults can cause short circuits, which in turn can lead to component failure. In order to find these defects, the DEFECTOMAT test electronics are used in conjunction with the fine wire sensor system. Material damage can thus be detected at an early stage and addressed accordingly.



Medical wire

Very delicate wires are often required in the medical sector. For example, these are used in hearing aids, cochlear implants, or implants for neurostimulation. In such cases, the implanted material must meet the very highest specifications so that patients are not exposed to unnecessary risk.

This makes a 100% test obligatory to ensure that no defects impair the function of the end product. When the DEFECTOMINI is used to inspect these delicate wires, even the smallest defects are found.

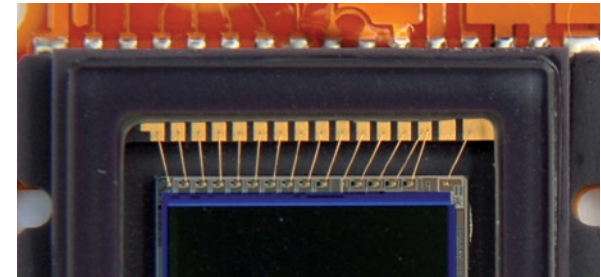

Bonding wire

In semiconductor manufacturing, hair-fine wires are used in the manufacture of chips. These so-called bonding wires link the connections of the integrated circuit with the electrical connections of the package.

Bonding wire is usually made of pure or alloyed gold and is approximately 12.5 µm in diameter. In order to attain the lowest possible chip failure rates while ensuring continuous production, the raw material used to make the bonding wire is first checked for material defects with the DEFECTOMINI.

(1) Fine wire sensor system
 (2) DEFECTOMAT® CI

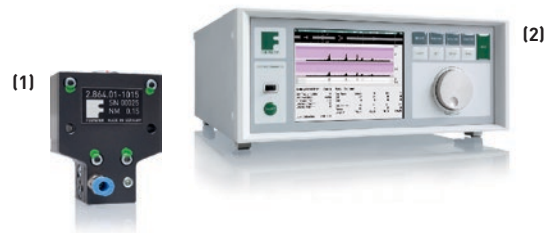



Welding wire

In gas fusion welding, a welding rod is often used as filler material. This drawn wire has a channel inside through which the flux flows during welding.

With our testing equipment, the raw material for the welding rod is checked in the production process for longitudinal and transverse defects. This is done in order to prevent serious defects in the material during the subsequent drawing process, which would render the wire unusable. Since the feed stock material is also a very thin wire, it is tested with the DEFECTOMINI.

- (1) DEFECTOMAT® DI
- (2) DEFECTOMINI®



Wire mesh in car tires

Car tires withstand high loads in road traffic on a daily basis. A mesh made of 1.7 mm diameter wire, known as tire cord, is built into the tires to stabilize them. To ensure that this wire mesh will not break and damage the tire carcass, the raw material is tested while still in the rolling mill. In addition, the wire's surface can be checked for very fine cracks before the fabric is manufactured.



NE-WIRE

Wire made from
non-ferrous metals

High-resolution testing of non-ferrous wires

Non-ferrous metal wires are used in many high-value products. Copper wire is found in electrical drive technologies and is used throughout the electrical industry to make power supply cables. Since copper wires are quite conductive, they're often found in consumer electronics, for example, as well as (in special forms) in superconductors. It's particularly important that the material is free of defects that would impair conductivity.

Wires made of precious metals such as titanium or platinum are also used in medical technology. And even if the conventional incandescent bulb is slowly dying out, the ultra-fine tungsten and molybdenum wires are still needed for diverse light sources.

No matter which non-ferrous metal these wires are made of, they all have one thing in common: High demands are placed on their material quality once they're worked into an end product. This is why our test equipment supports quality control directly in the manufacturing process.

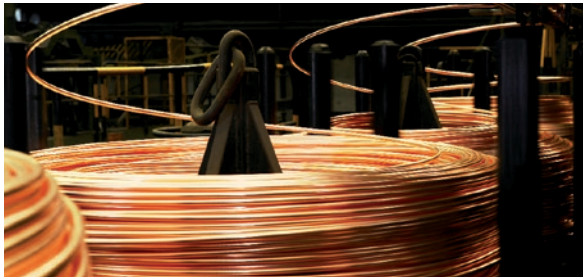

Copper wire

In the manufacture of copper wire, it is crucial to detect any ferritic inclusions, as they can lead to wire breakage in later processing steps. This, in turn, exacts high process costs due to the time and material lost. To detect potential ferritic inclusions, the eddy current coil is supplemented by DC magnetization; used in con-

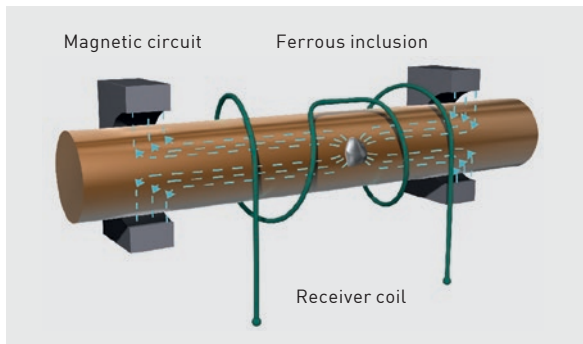

The principle behind ferritic inclusion detection

junction with the DEFECTOMAT CI plus a FERROMAT channel, it reliably identifies both surface defects and ferritic inclusions. The test results are then statistically evaluated and can be utilized for continuous process monitoring.



Aluminum wire

Aluminum wires are used, for example, in the cable industry, but also for wire nettings or in overhead lines as a carrier material with copper sheathing. To guarantee the surface quality, the aluminum wire is inspected for major defects right in the rolling mill. But ferritic inclusions inside the wire can also be detected. For this purpose, an encircling test coil adapted to the correct diameter is used in conjunction with the DEFECTOMAT, optionally with a FERROMAT channel.



(1) DEFECTOMAT® CI
(2) Encircling test coil



Tungsten and molybdenum wire

Wire made of tungsten or molybdenum is mainly used in light bulbs for the automotive industry and is characterized by relatively low conductivity. This means that a very high frequency is required for eddy current testing. FOERSTER has developed a fine wire sensor system specifically to reliably detect and document material defects in these mostly very thin wires.

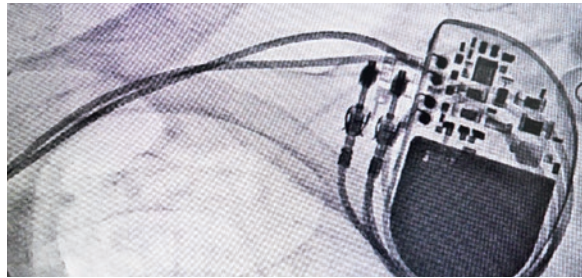

Platinum and titanium wire

Precious metal wires made of platinum or titanium are often used in medical technology, for example in cardiac pacemakers. Fine wire springs located at the distal end of the pacemaker's electrodes transmit electrical impulses to the heart muscle to restore a regular heartbeat.

The quality of the delicate wire – just 1 – 2 mm in diameter – is checked by the DEFECTOMINI, so that only perfect material is built into the pacemaker.



Superconductors

In MRI machines, powerful magnetic fields are generated by coil systems under strong electrical current. This requires superconductors. One reason that producing superconductors is very expensive is that they cannot be repaired once taken apart. If cracks go undetected, they grow and render the material unusable. This is why superconductors are tested, evaluated and, if necessary, repaired in a continuous process; the results are documented. An encircling test coil, in combination with the DEFECTOMAT test electronics, is used for this multifrequency test.

- (3) Fine wire sensor system
- (4) DEFECTOMAT® ECM
- (5) DEFECTOMINI®
- (6) DEFECTOMAT® DA



SPECIAL APPLICATIONS

Special applications

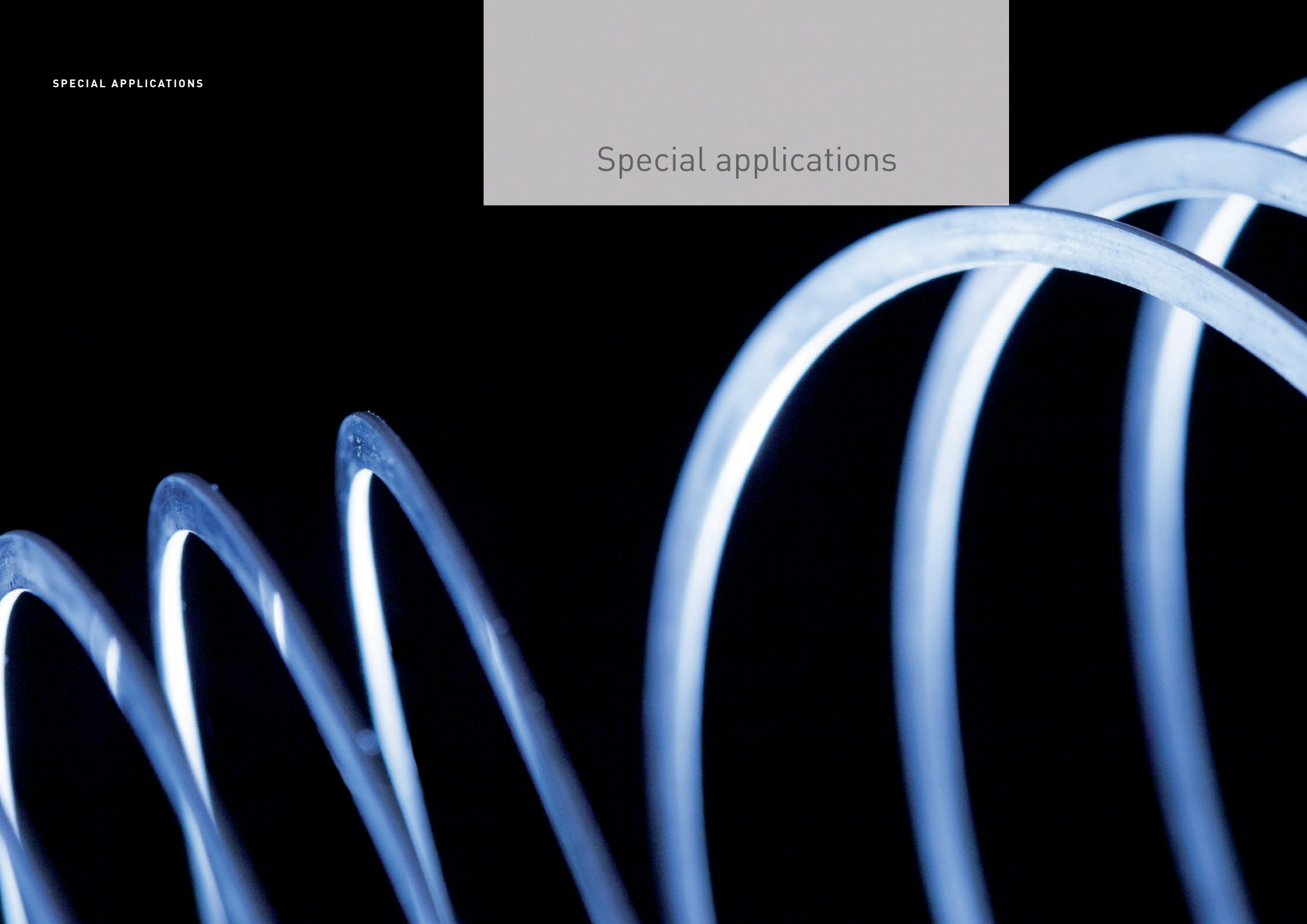

One solution for all your applications – FOERSTER

The name FOERSTER stands for excellence, but not only in standard applications. Over the decades, we've also made a name for ourselves in the development of test solutions for applications that are out of the ordinary.

Special profiles? No problem! Neither are special surfaces or unusual purposes. We're always happy to take on a new challenge and find the right test solution for you.

In addition, we also offer magneto-inductive tests for positive identification of your materials or for monitoring the magnetic phases in duplex and austenitic steels, just as an example.

Materials tested by our equipment can be found in places ranging from the operating theater to the manufacturing floor. This is how we create safety in a wide variety of application areas – day in, day out, and mostly in the background.

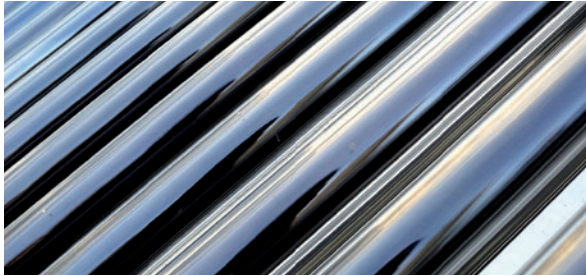

Determination of the magnetic phase in stainless, duplex and austenitic steels

Magnetic phases like ferrite in duplex steels and martensite in austenitic steels are indicators used to monitor the production process when specific mechanical attributes are desired. For example, a high proportion of martensite indicates brittleness and the associated risk of breakage.

The KOERZIMAT MS monitors the magnetic phase of stainless, duplex and austenitic steels after thermal treatment and cold forming. The measurement is fast and irrespective of sample geometry. Because prior preparation of the samples is not necessary, FOERSTER enables efficient quality monitoring of your material.

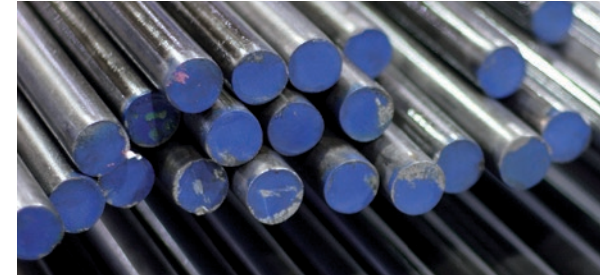

Mix-up prevention

Even in fully automated production processes, material mix-ups can occur; these can lead to costly damage to tools on the production line or even harm to users further downstream.

FOERSTER offers the MAGNATEST D-HZP as an ideal supplement to surface testing in order to reliably identify material mix-ups or incorrectly tempered rods in production. The testing and subsequent sorting of the bars takes place fully automatically and can be integrated into a FOERSTER test line, for example.

- (1) KOERZIMAT® MS
- (2) MAGNATEST® D-HZP

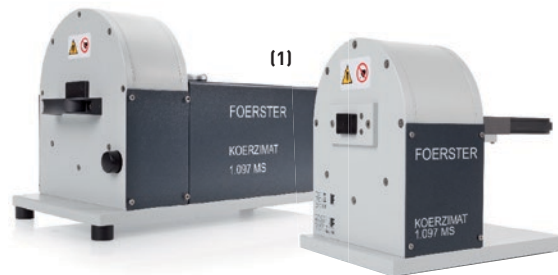



Piano wire

Its 88 keys and countless combinations for two hands make the piano one of the most complex instruments to play. But not only the playing is complex – so are the mechanics under the hood. The aptly named ‘piano wire’ is vital for sound generation. Depending on the depth of the notes, this drawn steel wire is additionally wound with a copper wire, all of which resonates when struck by the felt-covered hammer.

In order to produce a specific sound, the material must meet high quality requirements. Surface defects can exert negative effects on the resonance or even cause the wire to break. This is why the DEFECTOMAT and CIRCOGRAPH systems check the wire for both longitudinal and transverse surface defects. Behind the scenes, we add our note to the music.

- (1) DEFECTOMAT® CI
- (2) DEFECTOMINI®



Eddy current testing

Testing with an encircling coil

Eddy current testing uses high-frequency electromagnetic interactions to detect and evaluate surface defects. When the sensor technology is responsive enough, very high defect resolution is possible.

As the material under test passes lengthwise through the encircling test coil, any point defect or crack will interfere with the propagation of the generated eddy currents. Such irregularities are picked up via a separate receiver coil and displayed as a fault signal. Our continuous test coils are equipped by default with differential and absolute winding to detect both transverse and spot defects, and, depending on the application, longitudinal defects as well.

The test coils and sensor systems are used in combination with the DEFECTOMAT evaluation electronics and adapted to your specific testing task.

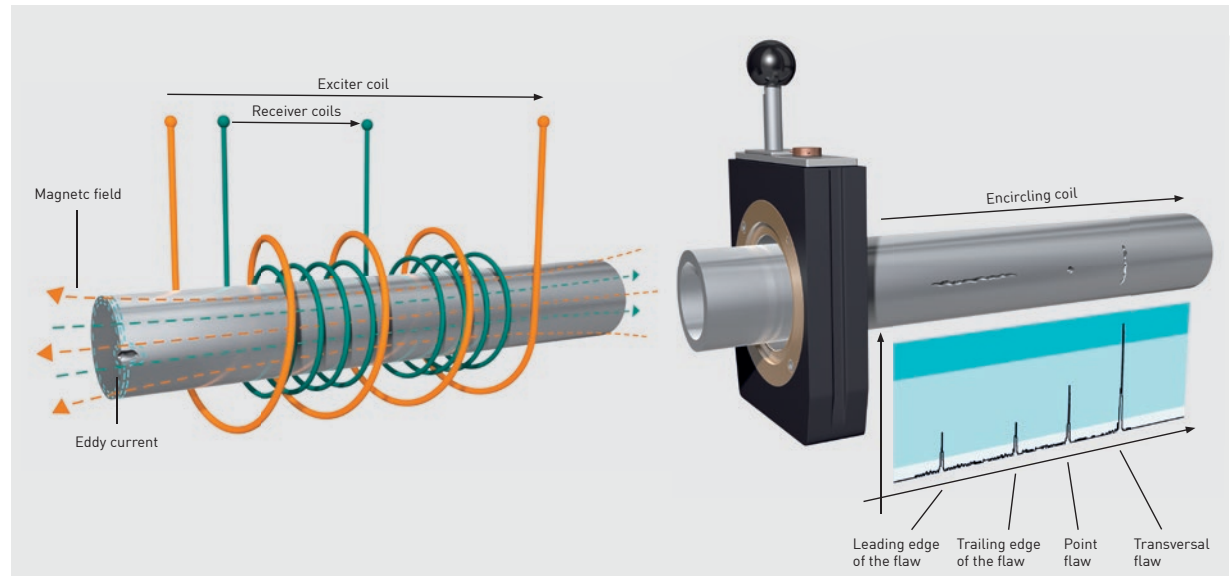

How eddy current testing works with an encircling test coil

- (1) DEFECTOMAT® DA
- (2) DEFECTOMAT® CI
- (3) DEFECTOMAT® DI
- (4) Encircling test coil
- (5) DEFECTOARRAY® sensor



Eddy current testing

Testing with rotating sensors

When using a rotating head for eddy current testing, the sensors quickly rotate around the material under test and scan the surface – without touching it – in a spiral. In this way, longitudinal defects such as cracks, over-rolling flaws or scabs come to light. Because each individual sensor is small, very high sensitivity can be achieved to catch even tiny defects. Another advantage is that longitudinal defects in the material are detected over their entire length.

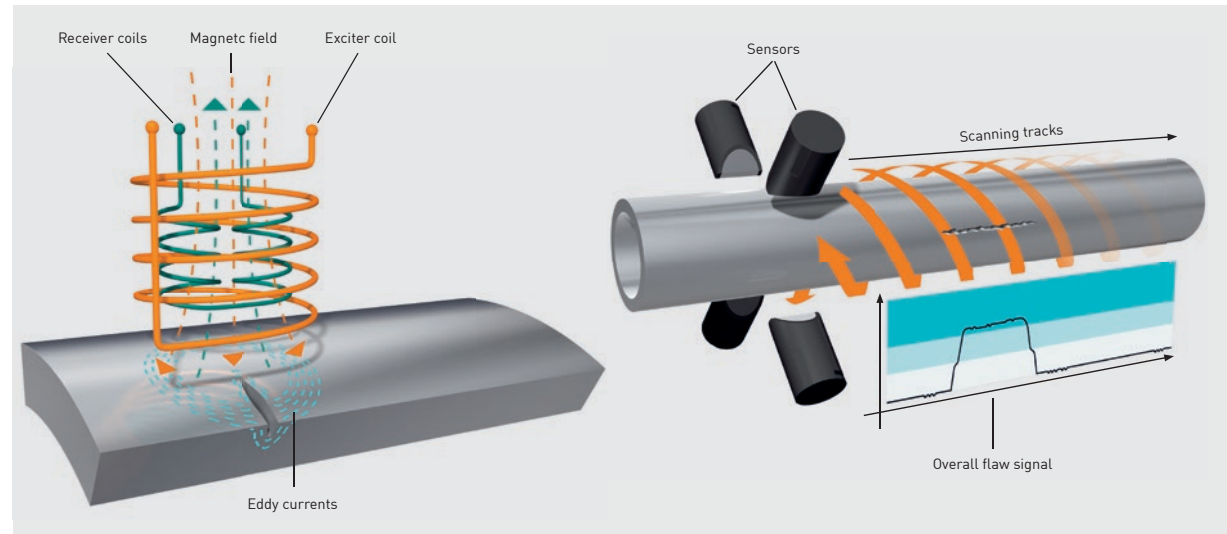

How eddy current testing works with rotating sensors

The FOERSTER rotating heads work in conjunction with the CIRCOGRAPH evaluation electronics. They are available in different dimensions to ensure optimum adaptation to your material diameter. Distance compensation enables sustained and reproducible inspection, even on test materials with special geometries or eccentrically guided material.

- (1) CIRCOGRAPH® CI
- (2) Sensor system Ro 35 L
- (3) CIRCOGRAPH® DA
- (4) CIRCOGRAPH® DI

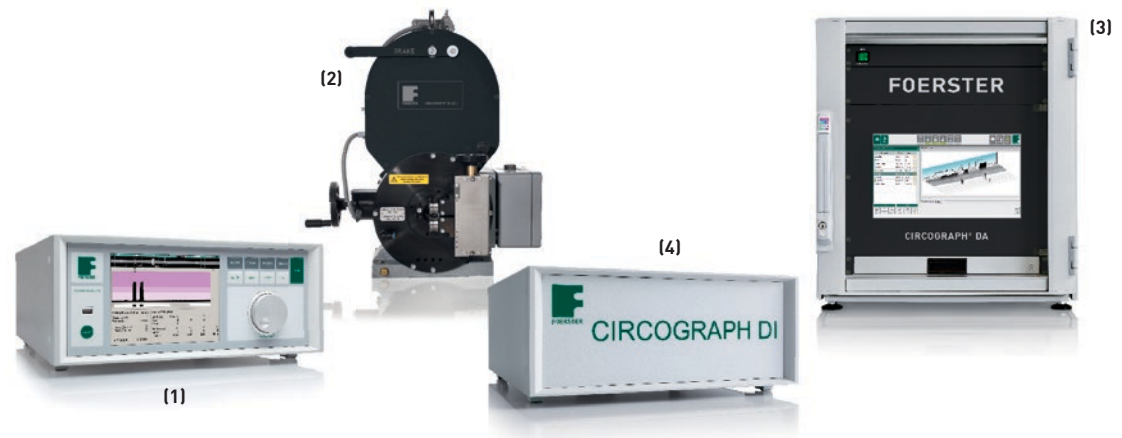

SYSTEM PROVIDER

Test lines for wire production

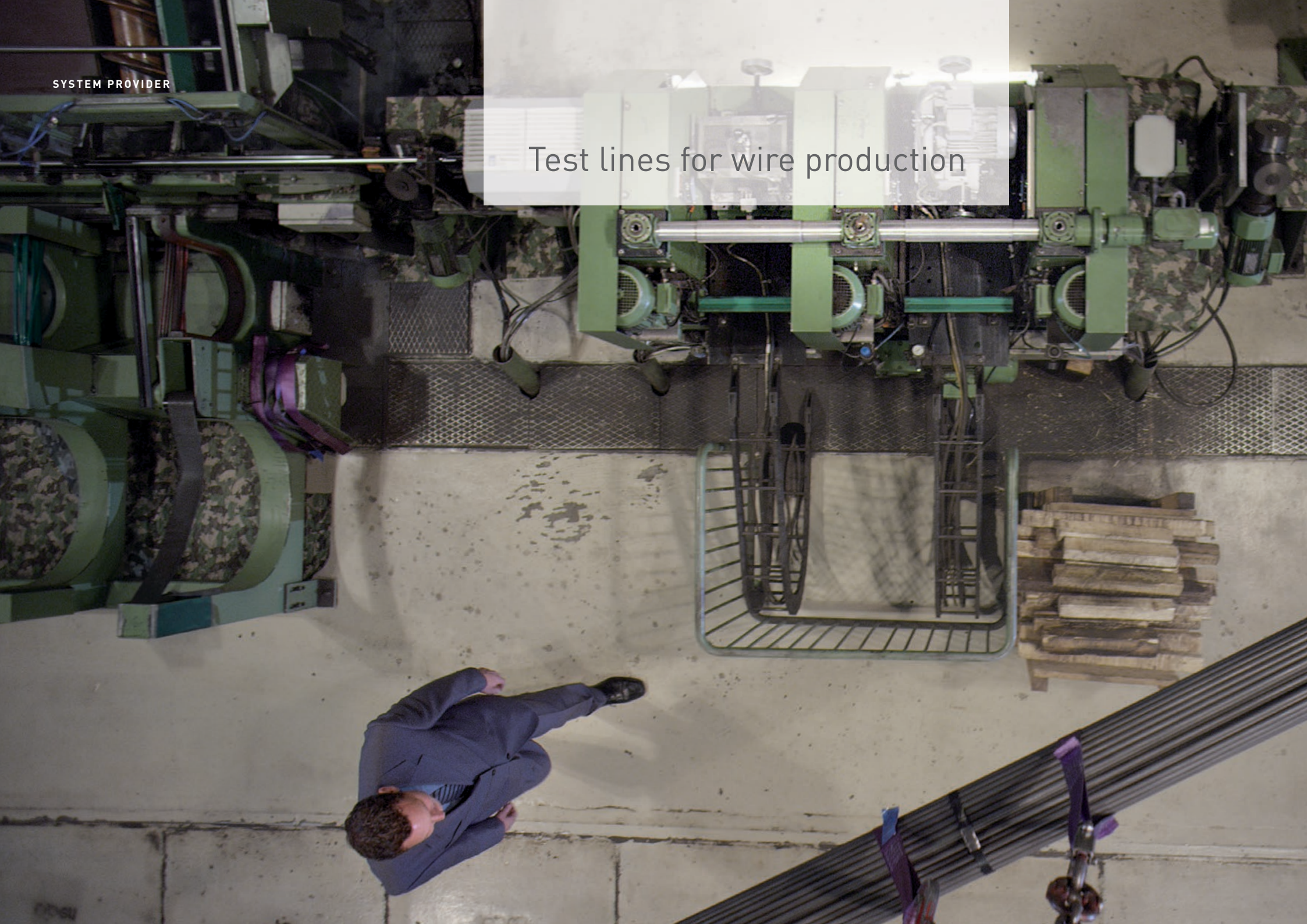

In addition to individual measuring and test systems, FOERSTER also offers complete test lines that are tailored to your specific requirements. Working side-by-side with you, our team of experts from the various specialist areas will plan the ideal test line for your purposes. Besides the FOERSTER test systems, this includes all drivers and tables necessary for reliable testing. On request, complementary test and measurement technologies can also be integrated into the line.

Our design department uses CAD drawings to prepare the plans required for implementation of the test line. Our experienced specialists develop and program the necessary software and interfaces for automation. With the FOERSTER Instrumentation Software, which

accommodates a central setting procedure for the various test systems as well as common display and logging of the test results, you're ready for the requirements of Industry 4.0.

Finally, your turnkey system is built and delivered. So that you can make full use of your test system from the very first day, we offer appropriate training directly on site or at our company's premises. Our worldwide service network, with its highly qualified service engineers, helps you to operate your equipment for maximum profitability. This includes regular inspections and maintenance, as well as 24-hour technical support. The one place to turn for all your questions: FOERSTER.

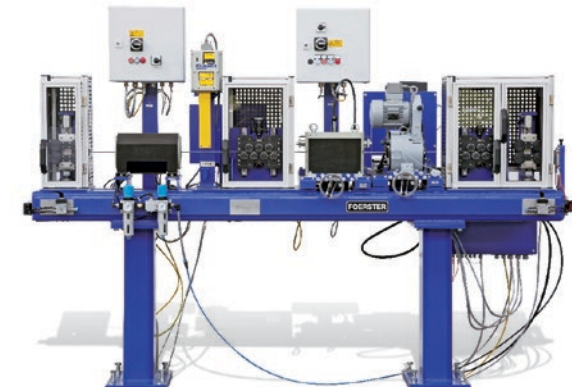
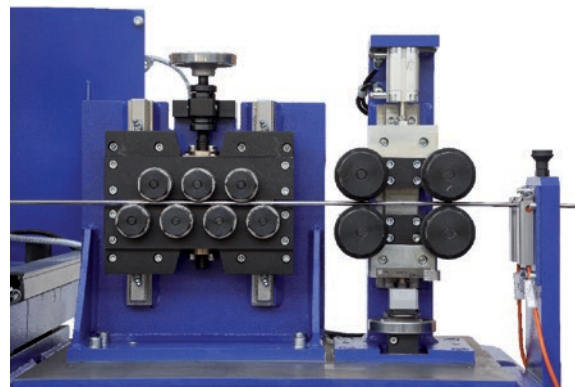

SOLUTION PROVIDER

FOERSTER offers solutions
for all your technologies



Application Laboratory

Our specialists in the Application Laboratory are there to provide comprehensive technical advice to our customers. Equipped with the very latest test equipment, the lab is perfectly suited for testing out new application scenarios. They carry out various tests based on samples provided by the customer. Depending on the test results, the best possible solution is defined – both for the technical equipment and for the setting of parameters. Our application specialists have a wide range of technical knowledge and can provide comprehensive support in finding specific solutions. Of course, we'd also be happy to help you on site.

We offer the following services:

- Practical advice on applications
- Executing feasibility studies
- Development of customized solutions under conditions like yours
- Optimization of the configuration parameters



Training

We offer comprehensive product training courses for operators and users so that you can make optimum use of your test devices – starting on day one. Our courses concentrate on the practical handling of FOERSTER test electronics and sensor systems. A central focus is on configuring the most important parameters to adapt the system to the test line and inspection task at hand.

In addition, in-depth training courses are also offered for service and maintenance. The training content can be modified to suit an individual customer's needs and delivered on-site at the test line in question, if desired, or it can take place in one of our training centers around the world.



Service

When it comes to FOERSTER test instruments, our customers count on top quality. In order to meet these expectations, an experienced service team and highly skilled engineers are available to perform on-site service and maintenance and, as necessary, to offer prompt and effective assistance.

And when problems occur outside normal working hours – FOERSTER has a 24-hour emergency hotline that can be reached 365 days a year. The FOERSTER service specialists there can start systematic error analysis right on the telephone. In the case of software installation or configuration questions, remote access often helps clear up problems immediately so that the device is quickly ready for use again.



WORLDWIDE

At home around the world –
rooted in Reutlingen, Germany



Ten subsidiaries. Representatives in over 60 countries. Operating worldwide.

To operate efficiently and prudently in global markets, a company needs partners with a global presence. From the very start, the FOERSTER Group has worked to build out its worldwide network of experts, which is continually expanding. Wherever in the world a need for testing arises – FOERSTER is there for you, a competent partner ready to respond to the demands and requirements of its customers.

Headquarters

- Institut Dr. Foerster GmbH & Co. KG, Germany

Subsidiaries

- Magnetische Pruefanlagen GmbH, Germany
- FOERSTER France SAS, France
- FOERSTER U.K. Limited, United Kingdom
- FOERSTER Italia S.r.l., Italy
- FOERSTER Russland AO, Russia
- FOERSTER Tecom, s.r.o., Czech Republic
- FOERSTER (Shanghai) NDT Instruments Co., Ltd., China
- FOERSTER Japan Ltd., Japan
- NDT Instruments Pte Ltd, Singapore
- FOERSTER Instruments Inc., USA



Institut Dr. Foerster GmbH & Co. KG

In Laisen 70 | 72766 Reutlingen | Germany

+49 7121 140 0 | info@foerstergroup.de

foerstergroup.de