

2018
CATALOGO



mini



Professional

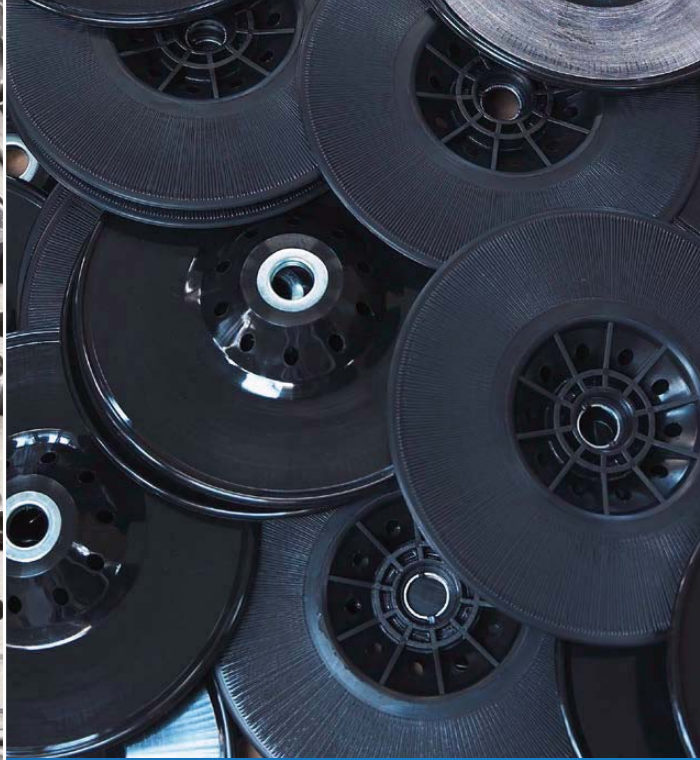

COMPETENZA, QUALITÀ E SPECIALIZZAZIONE. LA FORZA DI PG.

Produzione, qualità, gamma e specializzazione: su questi punti di forza PG ha fondato la propria struttura produttiva ed organizzativa.

L'affidabilità del marchio PG si sviluppa e si rafforza nel tempo: nata negli anni '50 come officina meccanica di precisione specializzata nella produzione di minuterie metalliche, all'inizio degli anni '80 pur proseguendo nella sua originaria attività, inizia la produzione e la vendita con il marchio PG di altri prodotti, ampliando e diversificando sempre più la gamma degli utensili ed accessori per trapano.

Una lunga esperienza e una realtà innovativa e dinamica in grado di garantire sempre risposte precise e specifiche, hanno consentito a PG di svolgere al proprio interno l'intero ciclo di produzione e controllo del prodotto cercando di ridurre il più possibile l'impatto ambientale durante il ciclo di fabbricazione, in un ambiente di lavoro sicuro, responsabile e collaborativo.

Identificazione e sviluppo dei nuovi progetti, selezione e qualifica delle materie prime, controlli in linea e sui prodotti finiti, ottimizzazione dei tempi operativi, adozione di metodi di gestione razionali e sicuri, scrupolosi test di approvazione e controlli rigorosi secondo gli attuali standard di sicurezza europei, sino ad arrivare ad un accurato studio del packaging per l'ottenimento di una esposizione ottimale nel punto vendita.

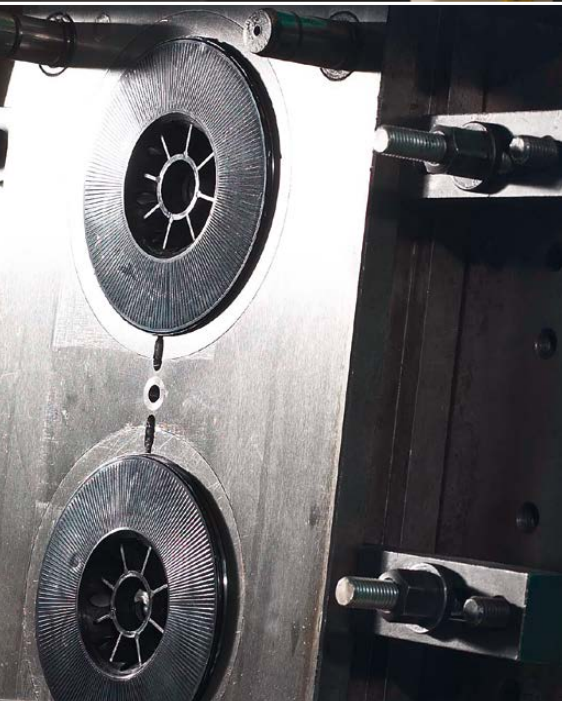
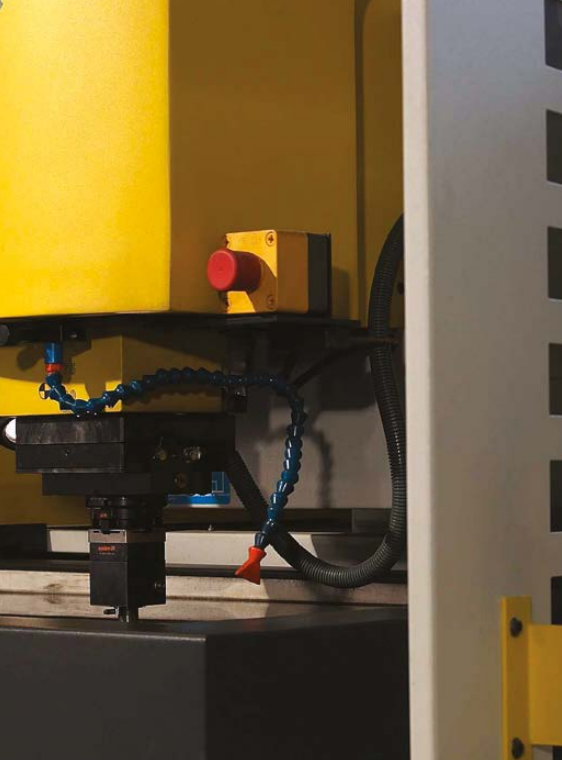
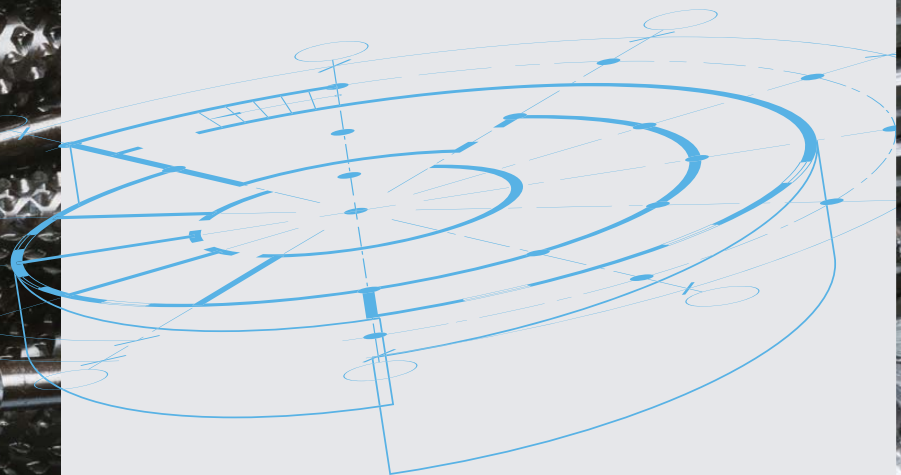
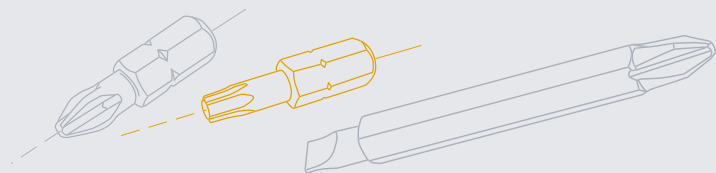



PG ha sviluppato e potenziato una rete di distribuzione capillare, efficiente e flessibile presente sui più importanti mercati che consente di offrire alla clientela una costante disponibilità al dialogo, un servizio di alto livello ed un elevato rapporto qualità-prezzo.

La gamma PG sempre in costante evoluzione è in grado di fornire un assortimento completo e compatibile con le più importanti marche di elettroattrezzi. Sono queste le caratteristiche e i vantaggi che fanno di PG una garanzia ed un punto di riferimento per chi desidera il meglio della produzione nel mercato del fai da te, ferramenta ed utensileria.

L'esperienza maturata da PG, lavorando quotidianamente al fianco dei propri clienti, le ha permesso di sviluppare un'approfondita conoscenza delle esigenze espositive e logistiche del punto vendita.

Lo studio attento del packaging, dei suoi colori e l'armonizzazione dei suoi formati, si è unito alla ricerca di soluzioni modulari e flessibili per l'esposizione. PG è così in grado di offrire un sistema di esposizione particolarmente efficace, che permette di presentare l'intera gamma di prodotti con un notevole impatto visivo per la clientela.

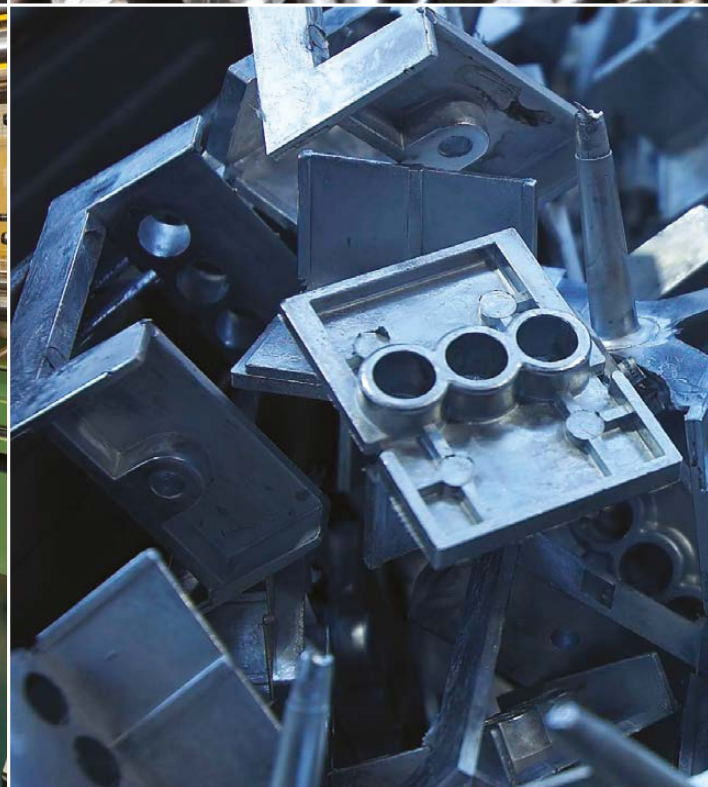
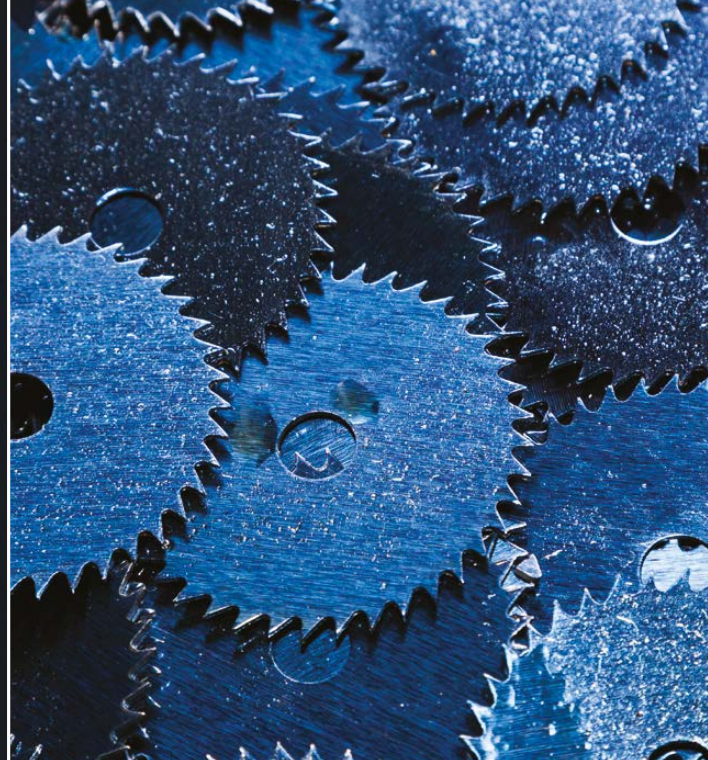
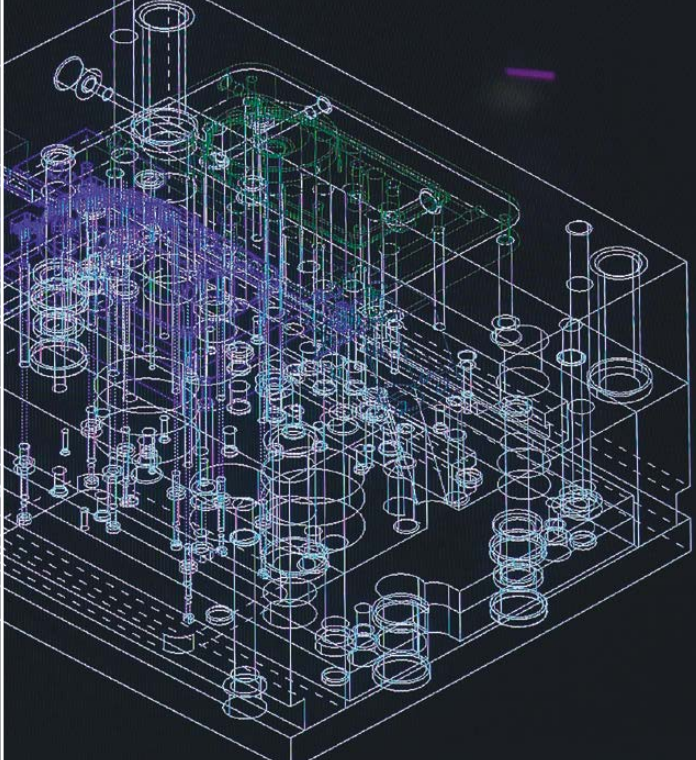



I TUOI COLLABORATORI PROFESSIONALI

Una gamma completa e specializzata di accessori e utensili per il fai da te compatibile con tutte le principali marche di elettroutensili e capace di rispondere con sicurezza e affidabilità a tutte le esigenze nel mercato del bricolage, ferramenta ed utensileria.



PICCOLI RESISTENTI E PRECISI

Una vasta linea di mini utensili ed accessori per modellismo, hobby, elettronica e artigianato, che unisce la massima precisione e resistenza alla forza dell'universalità, con un packaging moderno ed accattivante dal forte impatto visivo.

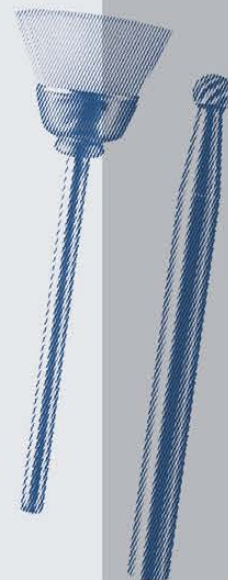



8
IDRAULICA



11
UTENSILI HSS



13
ACCESSORI UNIVERSALI



43
LIME E RASPE



45
INSERTI



48
SPAZZOLE



56
ANTI INFORTUNISTICA



67
SPINATURA



69
LAME PER SEGHETTI ALTERNATIVI



72
SEGHE A TAZZA



74
LAME PER SEGHE CIRCOLARI

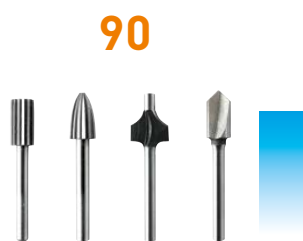

90
INTAGLIO
INCISIONE FRESATURA



93
SMERIGLIATURA
AFFILATURA



96
LEVIGATURA



104
ACCESSORI VARI



110
TRAPANI
TRASFORMATORI KIT

15



LUCIDATURA

18



LEVIGATURA
SMERIGLIATURA

30



TRONCATURA
SMERIGLIATURA

39

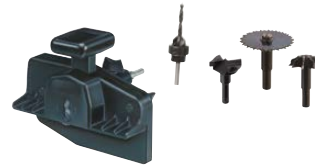

FRESE

41



MECCHIE E
PUNTE FORSTNER

60



MISCELATORI

61



CUTTER

63



UTENSILI PER LEGNO

65



GRAFFATRICI

66



FLESSOMETRI

75



MANDRINI

78



UTENSILI E
ACCESSORI VARI

80



SERRAGGIO

83



SUPPORTI

85



PUNTE

98



PULITURA LUCIDATURA

101



TAGLIO SGROSSATURA

103



PUNTE HSS PER FORATURA

FRESA PER RETTIFICARE LE SEDI DEI RUBINETTI

Filettatura esterna

103	con boccia conica \varnothing 28 x 25 mm fresa a 24 tagli 1/2	10	103006
212	con boccia conica \varnothing 28 x 25 mm 2 frese a 24 tagli 3/8 - 1/2 e 2 guarnizioni	10	212005
201	con boccia conica \varnothing 40 x 27 mm 4 frese a 24 tagli 3/8 - 1/2 - 3/4 - 1" 2 bocchie coniche \varnothing 27 - 32 mm	1	201009
203	con boccia conica \varnothing 32 x 27 mm 2 frese a 24 tagli 1/2 - 3/4 e 2 guarnizioni	1	203003
205	con boccia conica \varnothing 40 x 27 mm 4 frese a 24 tagli 3/8 - 1/2 - 3/4 - 1"	1	205007
204	con boccia conica \varnothing 65 x 65 mm 4 frese a 24 tagli 1" 1/8 - 1" 1/4 - 1" 1/2 - 2"	1	204147
207	con boccia conica \varnothing 40 x 27 mm 4 frese a 24 tagli 3/8 - 1/2 - 3/4 - 1"	1	207001
208	con doppio cono \varnothing 30 x 60 mm 6 frese a 24 tagli \varnothing 10 - 12 - 13 - 14 - 15 - 16 mm	1	208008
209	con doppio cono \varnothing 25 x 46 mm 3 frese a 24 tagli \varnothing 13 - 15 - 16 mm	1	209005

FRESA PER RETTIFICARE LE SEDI DEI RUBINETTI

Filettatura esterna - interna

202	con boccia conica \varnothing 42 x 42 mm 4 frese a 24 tagli 3/8 - 1/2 - 3/4 - 1"	1	202006
------------	---	---	--------

FRESA PER RETTIFICARE LE SEDI DEI RUBINETTI

Filettatura esterna - cilindrica

210	con boccia cilindrica \varnothing 33 x 38 mm 4 frese a 24 tagli 3/8 - 1/2 - 3/4 - 1"	1	210001
213	con boccia cilindrica \varnothing 28 x 24 mm 2 frese a 24 tagli 3/8 - 1/2 e 2 guarnizioni	10	213002

**FRESA A 24 TAGLI**

11.010	\varnothing 10 mm	10	110103
11.012	\varnothing 12 mm	10	110127
11.014	\varnothing 14 mm - 3/8	10	110141
11.017	\varnothing 17 mm - 1/2	10	110172
11.024	\varnothing 24 mm - 3/4	10	110240
11.028	\varnothing 28 mm - 1"	10	110288
11.034	\varnothing 34 mm - 1" 1/8	5	110349
11.038	\varnothing 38 mm - 1" 1/4	5	110387
11.043	\varnothing 43 mm - 1" 1/2	5	110431
11.055	\varnothing 55 mm - 2"	5	110554

**MORSETTO ALLARGATUBI** completo di punzone

300.00	per tubi \varnothing 10 - 12 - 14 - 16 mm	1	300009
304.00	per tubi \varnothing 10 - 12 - 14 - 16 - 18 - 20 - 22 mm	1	304007



CHIAVE PER LAVABO

305.00	uso destro e sinistro	5	305004
---------------	-----------------------	---	--------

TAGLIATUBO

Per tubi di rame, ottone, plastica e ferro



316.00	da 1/8 a 5/8 - 16 mm	5	316000
---------------	----------------------	---	--------

328.00	da 1/8 a 1" 1/8 - 28 mm	5	328003
---------------	-------------------------	---	--------

332.00	da 1/8 a 1" 1/4 - 32 mm	5	332000
---------------	-------------------------	---	--------

TAGLIATUBO TELESCOPICO

Per tubi di rame, ottone, plastica e ferro



332.35	da 1/8 a 1" 3/8 - 35 mm	5	332352
---------------	-------------------------	---	--------

334.00	da 1/4 a 1" 5/8 - 42 mm con 2 rotelle e svasatore estraibile	1	334004
---------------	---	---	--------

ROTELLA DI RICAMBIO

333.00	universale	10	333007
---------------	------------	----	--------

334.20	per art. 334.00	10	334202
---------------	-----------------	----	--------

UTENSILE CONICO PERFORATORE IN HSS per acciaio

800.00	da \varnothing 3 mm a \varnothing 14 mm - gambo \varnothing 6 mm - 550 RPM	1	800004
805.00	da \varnothing 6 mm a \varnothing 20 mm - gambo \varnothing 8 mm - 500 RPM	1	805009
810.00	da \varnothing 8 mm a \varnothing 30 mm - gambo \varnothing 10 mm - 400 RPM	1	810003
820.00	da \varnothing 20 mm a \varnothing 40 mm - gambo \varnothing 10 mm - 300 RPM	1	820002
825.00	da \varnothing 20 mm a \varnothing 50 mm - gambo \varnothing 10 mm - 200 RPM	1	825007

**FRESA A GRADINI IN HSS per acciaio**

825.50	da \varnothing 4 mm a \varnothing 12 mm - gambo \varnothing 6 mm - 800 RPM	1	825502
826.00	da \varnothing 4 mm a \varnothing 20 mm - gambo \varnothing 8 mm - 500 RPM	1	826004
828.00	da \varnothing 6 mm a \varnothing 30 mm - gambo \varnothing 10 mm - 400 RPM	1	828008
829.00	da \varnothing 3,5 mm a \varnothing 40 mm - gambo \varnothing 10 mm - 300 RPM	1	829005



FRESA CONICA IN HSS per acciaio

835.00	da \varnothing 0 mm a \varnothing 25 mm - gambo \varnothing 8 mm - 500 RPM	5	835006
835.50	da \varnothing 6 mm a \varnothing 32 mm - gambo \varnothing 10 mm - 500 RPM	1	835501
835.60	da \varnothing 6 mm a \varnothing 45 mm - gambo \varnothing 10 mm - 300 RPM	1	835600

SVASATORE IN HSS per acciaio - gambo \varnothing 8 mm

840.00	\varnothing 12 mm - 500 RPM	5	840000
845.00	\varnothing 16 mm - 500 RPM	5	845005
850.00	\varnothing 20 mm - 500 RPM	5	850009

FORALASTRA per tagliare laminati e metalli

214.00	attacco cilindrico \varnothing 8 mm - guida fissa centrante \varnothing 6 mm per forare da 20 mm a 123 mm - completo di punta HSS \varnothing 6 mm e chiave di servizio - utensile \square 5 mm in acciaio HSS al 5% di cobalto - 250 RPM	5	214009
215.00	attacco cilindrico \varnothing 12 mm - guida fissa centrante \varnothing 10 mm per forare da 25 mm a 217 mm - completo di punta HSS \varnothing 10 mm e chiave di servizio - utensile \square 6 mm in acciaio HSS al 5% di cobalto - 250 RPM	5	215006
216.00	attacco cilindrico \varnothing 8 mm - con punta HSS \varnothing 4 mm centrante per forare da 27 mm a 104 mm - utensile \square 5 mm in acciaio HSS al 5% di cobalto - 250 RPM	5	216003

UTENSILE DI RICAMBIO IN HSS al 5% di cobalto

214.10	\square 5 mm per art. 214.00	5	214108
215.10	\square 6 mm per art. 215.00	5	215105
216.10	\varnothing 5 mm per art. 216.00	5	216102

GHIERA CONICA per platorelli - collare ø **22** mm

218.00	14 MA	<input checked="" type="checkbox"/>	218007
220.00	8 MA	<input type="checkbox"/>	220000
220.50	10 MA - collare ø 16 mm	<input type="checkbox"/>	220505
221.00	10 MA	<input type="checkbox"/>	221007
222.00	14 MA	<input type="checkbox"/>	222004
223.00	5/8"	<input type="checkbox"/>	223001

**GHIERA PIANA** per mole a disco - collare ø **22** mm

219.00	14 MA	<input checked="" type="checkbox"/>	219004
224.00	8 MA	<input type="checkbox"/>	224008
225.00	10 MA	<input type="checkbox"/>	225005
226.00	14 MA	<input type="checkbox"/>	226002
227.00	5/8"	<input type="checkbox"/>	227009

**CHIAVE DI SERVIZIO** per ghiera

228.00	35 mm	<input checked="" type="checkbox"/>	228006
229.00	35 mm	<input type="checkbox"/>	229003
230.00	20/35 mm - regolabile	<input checked="" type="checkbox"/>	230009
231.00	20/35 mm - regolabile	<input type="checkbox"/>	231006

**FLANGIA POGGIA DISCO POSTERIORE**

250.00	per dischi ø 115 mm ø 41 mm - spessore 7,5 mm - foro ø 14 mm	<input type="checkbox"/>	250007
253.00	per dischi ø 230 mm ø 41 mm - spessore 9 mm - foro ø 14 mm	<input type="checkbox"/>	253008

**PERNO DI FISSAGGIO**

335.00	10,0 x 6 mm	<input checked="" type="checkbox"/>	335001
336.00	12,8 x 8 mm	<input type="checkbox"/>	336008
337.00	22,2 x 8 mm	<input type="checkbox"/>	337005



PLATORELLO DI GOMMA

338.00	Ø 125 mm - gambo Ø 6 mm	10	338002
338.05	Ø 180 mm - foro Ø 16 mm	10	338057
338.08	Ø 180 mm - foro Ø 16 mm	10	338088

PLATORELLO DI NYLON

338.10	Ø 100 mm - foro Ø 10 mm	10	338101
338.20	Ø 115 mm - foro Ø 14 mm	10	338200
338.22	Ø 178 mm - foro Ø 14 mm	10	338224
338.25	Ø 100 mm - foro Ø 10 mm	10	338255
338.30	Ø 115 mm - foro Ø 10 mm	10	338309
338.35	Ø 115 mm - foro Ø 14 mm	10	338354
338.40	Ø 115 mm - foro Ø 16 mm	10	338408
338.45	Ø 125 mm - foro Ø 14 mm	10	338453
338.50	Ø 125 mm - foro Ø 16 mm	10	338507
338.55	Ø 150 mm - foro Ø 14 mm	10	338552
338.60	Ø 150 mm - foro Ø 16 mm	10	338606
338.65	Ø 178 mm - foro Ø 14 mm	10	338651
338.70	Ø 178 mm - foro Ø 16 mm	10	338705
338.75	Ø 178 mm - foro Ø 14 mm - colore bianco	10	338750

PLATORELLO CON VELCRO BIADESIVO

perno Ø 10 mm - foro M14

338.80	Ø 115 mm	5	338804
338.82	Ø 125 mm	5	338828
338.85	Ø 150 mm	5	338859

CUFFIA CON LACCIO DI CHIUSURA

339.00	ø 140 mm	10	339009
339.20	ø 190 mm	10	339207

CUFFIA IN LANA D'AGNELLO CON FISSAGGIO VELCRO

339.22	ø 115 mm	10	339221
339.23	ø 125 mm	10	339238
339.24	ø 160 mm	10	339245

DISCO IN FELTRO

339.25	ø 80 x 10 mm - foro ø 13 mm	10	339252
339.27	ø 125 x 15 mm - foro ø 16 mm	10	339276
339.28	ø 150 x 20 mm - foro ø 16 mm	10	339283

DISCO IN FELTRO CON FISSAGGIO VELCRO

339.26	ø 125 mm	10	339269
---------------	----------	----	--------

PANNO IN FELTRO CON FISSAGGIO VELCRO per levigatrici a Delta

339.29	93 mm	10	339290
---------------	-------	----	--------

RUOTA IN TESSUTO

339.30	ø 80 mm - gambo ø 6 mm	10	339306
339.35	ø 100 mm - foro ø 20/13 mm	10	339351
339.40	ø 120 mm - foro ø 20/16 mm	10	339405
339.45	ø 150 mm - foro ø 20/16 mm	10	339450



**RUOTA IN SISAL E COTONE** per pre-lucidatura

339.46	Ø 80 mm - gambo Ø 6 mm	10	339467
---------------	------------------------	----	--------

339.49	Ø 150 mm - foro Ø 20/16 mm	10	339498
---------------	----------------------------	----	--------

**TAMPONE IN SPUGNA**

339.50	Ø 125 mm - gambo Ø 6 mm	1	339504
---------------	-------------------------	---	--------

339.60	Ø 175 mm - foro M14	1	339603
---------------	---------------------	---	--------

**TAMPONE DI RICAMBIO**

339.62	Ø 125 mm	1	339627
---------------	----------	---	--------

339.64	Ø 175 mm	1	339641
---------------	----------	---	--------

**TAMPONE CON FISSAGGIO VELCRO**

339.66	Ø 115 mm	1	339665
---------------	----------	---	--------

339.67	Ø 125 mm	1	339672
---------------	----------	---	--------

339.68	Ø 160 mm	1	339689
---------------	----------	---	--------

**PASTA PER LUCIDARE**

359.36	2 stick pasta marrone per pre-lucidatura	10	359366
---------------	--	----	--------

359.37	2 stick pasta blu per lucidatura finale	10	359373
---------------	---	----	--------

359.38	2 stick pasta assortiti	10	359380
---------------	-------------------------	----	--------



RUOTA A LAMELLE IN PANNO ABRASIVOAggressività leggera - grana **150**

359.40	∅ 50 x 25 mm - gambo ∅ 6 mm	5	359403
359.42	∅ 75 x 45 mm - gambo ∅ 6 mm	5	359427
359.44	∅ 100 x 50 mm - gambo ∅ 6 mm	5	359441
359.70	∅ 150 x 25 mm - foro ∅ 32/20 mm	5	359700

**RUOTA A LAMELLE IN PANNO E TELA ABRASIVA**Aggressività media - grana **150**

359.46	∅ 50 x 25 mm - gambo ∅ 6 mm	5	359465
359.48	∅ 75 x 45 mm - gambo ∅ 6 mm	5	359489
359.50	∅ 100 x 50 mm - gambo ∅ 6 mm	5	359502
359.72	∅ 150 x 25 mm - foro ∅ 32/20 mm	5	359724

**DISCO IN FIBRE DI NYLON**

359.82	piano ∅ 100 mm - foro ∅ 13 mm	5	359823
359.86	a centro depresso ∅ 115 mm - foro ∅ 22 mm	5	359861



TAMPONE DI GOMMA

339.70	125 x 70 mm - con fissaggio manuale	10	339702
339.72	125 x 70 mm - con fissaggio velcro e manuale	5	339726
339.73	con fissaggio velcro per dischi ø 125 mm - per superfici concave	5	339733
339.74	con fissaggio velcro per dischi ø 125 mm	5	339740
339.75	con fissaggio velcro per dischi ø 125 mm	5	339757
339.76	con fissaggio velcro per dischi ø 150 mm	5	339764
339.79	MINI - con fissaggio velcro per fogli - per rifinitura	5	339795

FOGLI ABRASIVI VELCRO per MINI tampone di gomma

348.25	10 fogli grana grossa per art. 339.79	5	348254
348.26	10 fogli grana media per art. 339.79	5	348261
348.27	10 fogli grana fine per art. 339.79	5	348278

SPUGNA ABRASIVA

339.80	1 spugna abrasiva - doppia grana 60/100 - per legno e metallo	10	339801
339.81	250 spugne abrasive - doppia grana 60/100 - per legno e metallo	1	339818
339.85	24 spugne abrasive - doppia grana 60/100 - per legno e metallo - in espositore self-service	1	339856
339.90	2 spugne abrasive - grana 100 - per metallo e carrozzeria	10	339900
339.91	250 spugne abrasive - grana 100 - per metallo e carrozzeria	1	339917

DISCHI DI CARTA ABRASIVA - ø 125 mm - supporto 160 g

340.00	15 dischi grana 50	<input checked="" type="checkbox"/>	340005
341.00	15 dischi grana 80	<input checked="" type="checkbox"/>	341002
342.00	15 dischi grana 120	<input checked="" type="checkbox"/>	342009
343.00	15 dischi grane assortite	<input checked="" type="checkbox"/>	343006

DISCHI DI CARTA ABRASIVA - ø 125 mm - supporto 230 g

344.00	5 dischi grana 50	<input checked="" type="checkbox"/>	344003
344.10	5 dischi grana 80	<input checked="" type="checkbox"/>	344102
344.20	5 dischi grana 120	<input checked="" type="checkbox"/>	344201
344.30	5 dischi grane assortite	<input checked="" type="checkbox"/>	344300

DISCHI DI TELA ABRASIVA - ø 125 mm

350.00	6 dischi grana 40	<input checked="" type="checkbox"/>	350004
351.00	6 dischi grana 80	<input checked="" type="checkbox"/>	351001
352.00	6 dischi grana 150	<input checked="" type="checkbox"/>	352008
353.00	6 dischi grane assortite	<input checked="" type="checkbox"/>	353005

DISCHI DI CARTA E TELA ABRASIVA - ø 125 mm

355.00	4 dischi tela + 8 dischi carta	<input checked="" type="checkbox"/>	355009
---------------	---------------------------------------	-------------------------------------	--------

DISCHI SU FIBRA - ø 115 mm

347.00	6 dischi grana 36	<input checked="" type="checkbox"/>	347004
347.10	6 dischi grana 60	<input checked="" type="checkbox"/>	347103
347.20	6 dischi grana 100	<input checked="" type="checkbox"/>	347202

DISCHI SU FIBRA - ø 180 mm

348.00	6 dischi grana 36	<input checked="" type="checkbox"/>	348001
348.10	6 dischi grana 60	<input checked="" type="checkbox"/>	348100
348.20	6 dischi grana 100	<input checked="" type="checkbox"/>	348209



FOGLI ABRASIVI VELCRO con fori - 93 mm - per levigatrici a DELTA

348.30	5 fogli grana 40	<input checked="" type="checkbox"/>	348308
348.31	25 fogli grana 40	<input type="checkbox"/>	348315
348.35	5 fogli grana 60	<input checked="" type="checkbox"/>	348353
348.36	25 fogli grana 60	<input type="checkbox"/>	348360
348.40	5 fogli grana 80	<input checked="" type="checkbox"/>	348407
348.41	25 fogli grana 80	<input type="checkbox"/>	348414
348.45	5 fogli grana 120	<input checked="" type="checkbox"/>	348452
348.46	25 fogli grana 120	<input type="checkbox"/>	348469
348.50	5 fogli grana 240	<input checked="" type="checkbox"/>	348506
348.51	25 fogli grana 240	<input type="checkbox"/>	348513
348.56	25 fogli grane assortite	<input type="checkbox"/>	348568

DISCHI ABRASIVI VELCRO - ø 115 mm

349.00	10 dischi grana 40	<input checked="" type="checkbox"/>	349008
349.01	25 dischi grana 40	<input type="checkbox"/>	349015
349.10	10 dischi grana 120	<input checked="" type="checkbox"/>	349107
349.11	25 dischi grana 120	<input type="checkbox"/>	349114
349.20	10 dischi grana 240	<input checked="" type="checkbox"/>	349206
349.21	25 dischi grana 240	<input type="checkbox"/>	349213
349.30	10 dischi grane assortite	<input checked="" type="checkbox"/>	349305
349.31	25 dischi grane assortite	<input type="checkbox"/>	349312

DISCHI ABRASIVI VELCRO - ø 125 mm

349.55	10 dischi grana 40	<input checked="" type="checkbox"/>	349558
349.56	25 dischi grana 40	<input type="checkbox"/>	349565
349.60	10 dischi grana 120	<input checked="" type="checkbox"/>	349602
349.61	25 dischi grana 120	<input type="checkbox"/>	349619
349.65	10 dischi grana 240	<input checked="" type="checkbox"/>	349657
349.66	25 dischi grana 240	<input type="checkbox"/>	349664
349.70	10 dischi grane assortite	<input checked="" type="checkbox"/>	349701
349.71	25 dischi grane assortite	<input type="checkbox"/>	349718

DISCHI ABRASIVI VELCRO con fori - ø 115 mm

349.33	10 dischi grana 40	<input checked="" type="checkbox"/>	10	349336
349.34	25 dischi grana 40	<input type="checkbox"/>	1	349343
349.35	10 dischi grana 80	<input checked="" type="checkbox"/>	10	349350
349.36	25 dischi grana 80	<input type="checkbox"/>	1	349367
349.40	10 dischi grana 120	<input checked="" type="checkbox"/>	10	349404
349.41	25 dischi grana 120	<input type="checkbox"/>	1	349411
349.45	10 dischi grana 240	<input checked="" type="checkbox"/>	10	349459
349.46	25 dischi grana 240	<input type="checkbox"/>	1	349466
349.50	10 dischi grane assortite	<input checked="" type="checkbox"/>	10	349503
349.51	25 dischi grane assortite	<input type="checkbox"/>	1	349510

**DISCHI ABRASIVI VELCRO con fori - ø 125 mm**

349.73	10 dischi grana 40	<input checked="" type="checkbox"/>	10	349732
349.74	25 dischi grana 40	<input type="checkbox"/>	1	349749
349.75	10 dischi grana 80	<input checked="" type="checkbox"/>	10	349756
349.76	25 dischi grana 80	<input type="checkbox"/>	1	349763
349.80	10 dischi grana 120	<input checked="" type="checkbox"/>	10	349800
349.81	25 dischi grana 120	<input type="checkbox"/>	1	349817
349.85	10 dischi grana 240	<input checked="" type="checkbox"/>	10	349855
349.86	25 dischi grana 240	<input type="checkbox"/>	1	349862
349.90	10 dischi grane assortite	<input checked="" type="checkbox"/>	10	349909
349.91	25 dischi grane assortite	<input type="checkbox"/>	1	349916

**DISCHI ABRASIVI VELCRO con fori - ø 150 mm**

349.95	10 dischi grana 40	<input checked="" type="checkbox"/>	10	349954
349.96	10 dischi grana 80	<input checked="" type="checkbox"/>	10	349961
349.97	10 dischi grana 120	<input checked="" type="checkbox"/>	10	349978
349.98	10 dischi grana 240	<input checked="" type="checkbox"/>	10	349985
349.99	10 dischi grane assortite	<input checked="" type="checkbox"/>	10	349992



FOGLI DI CARTA ABRASIVA - 230 x 280 mm

355.60	6 fogli grana 60	<input type="checkbox"/>	355603
355.62	6 fogli grana 100	<input type="checkbox"/>	355627
355.64	6 fogli grana 150	<input type="checkbox"/>	355641
355.66	6 fogli grane assortite	<input type="checkbox"/>	355665
FC.01	1 foglio grana 40	<input type="checkbox"/>	083346
FC.03	1 foglio grana 60	<input type="checkbox"/>	083353
FC.04	1 foglio grana 80	<input type="checkbox"/>	083360
FC.05	1 foglio grana 100	<input type="checkbox"/>	083377
FC.06	1 foglio grana 120	<input type="checkbox"/>	083384
FC.07	1 foglio grana 150	<input type="checkbox"/>	083391
FC.08	1 foglio grana 180	<input type="checkbox"/>	083407

FOGLI DI CARTA ABRASIVA IMPERMEABILE - 230 x 280 mm

355.70	6 fogli grana 180	<input type="checkbox"/>	355702
355.72	6 fogli grana 320	<input type="checkbox"/>	355726
355.74	6 fogli grana 600	<input type="checkbox"/>	355740
355.76	6 fogli grane assortite	<input type="checkbox"/>	355764
WSC.01	1 foglio grana 100	<input type="checkbox"/>	085982
WSC.02	1 foglio grana 120	<input type="checkbox"/>	085999
WSC.03	1 foglio grana 150	<input type="checkbox"/>	086002
WSC.04	1 foglio grana 180	<input type="checkbox"/>	086019
WSC.05	1 foglio grana 220	<input type="checkbox"/>	086026
WSC.06	1 foglio grana 240	<input type="checkbox"/>	086033
WSC.07	1 foglio grana 280	<input type="checkbox"/>	086040
WSC.08	1 foglio grana 320	<input type="checkbox"/>	086057
WSC.09	1 foglio grana 360	<input type="checkbox"/>	086064
WSC.10	1 foglio grana 400	<input type="checkbox"/>	086071
WSC.11	1 foglio grana 500	<input type="checkbox"/>	086088
WSC.12	1 foglio grana 600	<input type="checkbox"/>	086095

FOGLI DI TELA AL CORINDONE - 230 x 280 mm

355.80	6 fogli grana 60	10	355801
355.82	6 fogli grana 120	10	355825
355.84	6 fogli grana 240	10	355849
355.86	6 fogli grane assortite	10	355863
T.01	1 foglio grana 30	50	085869
T.03	1 foglio grana 40	50	085876
T.04	1 foglio grana 60	50	085883
T.05	1 foglio grana 80	50	085890
T.06	1 foglio grana 100	50	085906
T.07	1 foglio grana 120	50	085913
T.08	1 foglio grana 150	50	085920
T.09	1 foglio grana 180	50	085937
T.10	1 foglio grana 220	50	085944
T.11	1 foglio grana 240	50	085951
T.12	1 foglio grana 320	50	085968
T.13	1 foglio grana 400	50	085975

**ROTOLO DI CARTA ABRASIVA - 120 mm x 50 yds**

RC.01	grana 40	1	085159
RC.03	grana 60	1	085166
RC.04	grana 80	1	085173
RC.05	grana 100	1	085180
RC.06	grana 120	1	085197
RC.07	grana 150	1	085203
RC.08	grana 180	1	085210
RC.09	grana 240	1	085227



MINI ROTOLO DI CARTA ABRASIVA - 120 mm x 5 m

355.90	grana 50	<input checked="" type="checkbox"/>	355900
355.92	grana 80	<input checked="" type="checkbox"/>	355924
355.94	grana 120	<input checked="" type="checkbox"/>	355948

MINI ROTOLO DI CARTA ABRASIVA VELCRO - 120 mm x 3 m

355.96	grana 50	<input checked="" type="checkbox"/>	355962
355.97	grana 80	<input checked="" type="checkbox"/>	355979
355.98	grana 120	<input checked="" type="checkbox"/>	355986

FOGLI DI CARTA ABRASIVA - 93 x 230 mm

356.00	10 fogli grana 50	<input checked="" type="checkbox"/>	356006
356.01	25 fogli grana 50	<input type="checkbox"/>	356013
356.10	10 fogli grana 80	<input checked="" type="checkbox"/>	356105
356.11	25 fogli grana 80	<input type="checkbox"/>	356112
356.20	10 fogli grana 120	<input checked="" type="checkbox"/>	356204
356.21	25 fogli grana 120	<input type="checkbox"/>	356211
356.30	10 fogli grane assortite	<input checked="" type="checkbox"/>	356303
356.31	25 fogli grane assortite	<input type="checkbox"/>	356310

FOGLI DI CARTA ABRASIVA - 115 x 280 mm

357.00	10 fogli grana 50	<input checked="" type="checkbox"/>	357003
357.01	25 fogli grana 50	<input type="checkbox"/>	357010
357.10	10 fogli grana 80	<input checked="" type="checkbox"/>	357102
357.11	25 fogli grana 80	<input type="checkbox"/>	357119
357.20	10 fogli grana 120	<input checked="" type="checkbox"/>	357201
357.21	25 fogli grana 120	<input type="checkbox"/>	357218
357.30	10 fogli grane assortite	<input checked="" type="checkbox"/>	357300
357.31	25 fogli grane assortite	<input type="checkbox"/>	357317

FOGLI ABRASIVI VELCRO con fori - 93 x 185 mm

Per Atlas Copco, Bosch, Festo, Holzher, Peugeot

354.00	10 fogli grana 40	5	354002
354.03	10 fogli grana 80	5	354033
354.06	10 fogli grana 120	5	354064
354.09	10 fogli grana 180	5	354095
354.12	10 fogli grana assortite	5	354125

**FOGLI ABRASIVI VELCRO con fori - 93 x 185 mm**

Per Black & Decker KA 186, KA 186E

354.15	10 fogli grana 40	5	354156
354.18	10 fogli grana 80	5	354187
354.21	10 fogli grana 120	5	354217
354.24	10 fogli grana 180	5	354248
354.27	10 fogli grana assortite	5	354279

**FOGLI ABRASIVI con fori - 93 x 230 mm**

Per Bosch, Festo, Makita, Metabo, Peugeot, Ryobi, Skil, Stayer, Wagner

354.30	10 fogli grana 40	5	354309
354.33	10 fogli grana 80	5	354330
354.36	10 fogli grana 120	5	354361
354.39	10 fogli grana 180	5	354392
354.42	10 fogli grana assortite	5	354422



FOGLI ABRASIVI con fori - 93 x 230 mm

Per AEG, Black & Decker, Bosch, Casals, Einhell, Peugeot

354.45	10 fogli grana 40	5	354453
354.48	10 fogli grana 80	5	354484
354.51	10 fogli grana 120	5	354514
354.54	10 fogli grana 180	5	354545
354.57	10 fogli grana assortite	5	354576

FOGLI ABRASIVI VELCRO con fori - 115 x 230 mm

Per AEG, Bosch, Fein, Festo, Holzher, Kress, Mafell, Makita, Peugeot

354.60	10 fogli grana 40	5	354606
354.63	10 fogli grana 80	5	354637
354.66	10 fogli grana 120	5	354668
354.69	10 fogli grana 180	5	354699
354.72	10 fogli grana assortite	5	354729

FOGLI ABRASIVI con fori - 115 x 280 mm

Per AEG, Atlas Copco, Black & Decker, Bosch, Elu, Fein, Festo

354.75	10 fogli grana 40	5	354750
354.78	10 fogli grana 80	5	354781
354.81	10 fogli grana 120	5	354811
354.84	10 fogli grana 180	5	354842
354.87	10 fogli grana assortite	5	354873

NASTRI ABRASIVI - 400 x 60 mm

Per Bosch PBS 60/60E

355.10	3 nastri grana 40	<input checked="" type="checkbox"/>	355108
355.11	3 nastri grana 60	<input checked="" type="checkbox"/>	355115
355.12	3 nastri grana 80	<input checked="" type="checkbox"/>	355122
355.13	3 nastri grana 100	<input checked="" type="checkbox"/>	355139
355.14	3 nastri grana 150	<input checked="" type="checkbox"/>	355146

**NASTRI ABRASIVI - 560 x 100 mm**

Per Atlas Copco, Elu, Ryobi, Festo

355.15	3 nastri grana 40	<input type="checkbox"/>	355153
355.16	3 nastri grana 60	<input type="checkbox"/>	355160
355.17	3 nastri grana 80	<input type="checkbox"/>	355177
355.18	3 nastri grana 100	<input type="checkbox"/>	355184
355.19	3 nastri grana 150	<input type="checkbox"/>	355191

**NASTRI ABRASIVI - 610 x 100 mm**

Per Atlas Copco, Hitachi, Makita, Ryobi, Wolf

355.20	3 nastri grana 40	<input type="checkbox"/>	355207
355.21	3 nastri grana 60	<input type="checkbox"/>	355214
355.22	3 nastri grana 80	<input type="checkbox"/>	355221
355.23	3 nastri grana 100	<input type="checkbox"/>	355238
355.24	3 nastri grana 150	<input type="checkbox"/>	355245

**NASTRI ABRASIVI - 620 x 100 mm**

Per Atlas Copco, Bosch, Makita, Metabo

355.25	3 nastri grana 40	<input type="checkbox"/>	355252
355.26	3 nastri grana 60	<input type="checkbox"/>	355269
355.27	3 nastri grana 80	<input type="checkbox"/>	355276
355.28	3 nastri grana 100	<input type="checkbox"/>	355283
355.29	3 nastri grana 150	<input type="checkbox"/>	355290



imballo PG



imballo neutro

NASTRI ABRASIVI - 533 x 75 mm

Per Bosch PBS 75/75E, Atlas Copco, Metabo, Hitachi, Makita, Holz Her



357.35	3 nastri grana 40	<input type="checkbox"/>	357355
357.36	3 nastri grana 60	<input type="checkbox"/>	357362
357.37	3 nastri grana 80	<input type="checkbox"/>	357379
357.38	3 nastri grana 100	<input type="checkbox"/>	357386
357.39	3 nastri grana 150	<input type="checkbox"/>	357393

NASTRI ABRASIVI - 410 x 65 mm

Per Black & Decker DN 83/BD 83, Atlas Copco HBS 65, Metabo, Holz Her, Kress



357.40	3 nastri grana 40	<input type="checkbox"/>	357409
357.45	3 nastri grana 60	<input type="checkbox"/>	357454
357.50	3 nastri grana 80	<input type="checkbox"/>	357508
357.55	3 nastri grana 100	<input type="checkbox"/>	357553
357.57	3 nastri grana 150	<input type="checkbox"/>	357577

NASTRI ABRASIVI - 510 x 75 mm

Per Black & Decker DN 85/BD 85/SR 500 E



357.60	3 nastri grana 40	<input type="checkbox"/>	357607
357.65	3 nastri grana 60	<input type="checkbox"/>	357652
357.70	3 nastri grana 80	<input type="checkbox"/>	357706
357.75	3 nastri grana 100	<input type="checkbox"/>	357751
357.77	3 nastri grana 150	<input type="checkbox"/>	357775

NASTRI ABRASIVI - 457 x 75 mm

Per B&D KA/85, Stayer LN 75, Skil 1200 H/120 SN, Peugeot, Makita

357.78	3 nastri grana 40	<input type="checkbox"/>	357782
357.79	3 nastri grana 60	<input type="checkbox"/>	357799
357.80	3 nastri grana 80	<input type="checkbox"/>	357805
357.81	3 nastri grana 100	<input type="checkbox"/>	357812
357.82	3 nastri grana 150	<input type="checkbox"/>	357829

SMERIGLIATORE AD ESPANSIONE

357.96	Ø 45 x 30 mm - gambo Ø 6 mm	10	357966
357.98	3 nastri grane assortite per art. 357.96	10	357980

**RUOTA LAMELLARE ABRASIVA - gambo Ø 6 mm - grana 80**

358.40	Ø 40 x 20 mm	10	358406
358.50	Ø 50 x 20 mm	10	358505
358.60	Ø 60 x 40 mm	10	358604
358.80	Ø 80 x 30 mm	10	358802
358.90	40 ruote lamellari abrasive assortite in espositore self-service 15 Ø 40 x 20 mm - 15 Ø 50 x 20 mm 10 Ø 60 x 30 mm	1	358901

**RUOTA LAMELLARE ABRASIVA**

Ø x spessore x gambo	RPM	grana 60		grana 80		grana 120	
		codice	EAN13 8011017	codice	EAN13 8011017	codice	EAN13 8011017
30 x 10 x 6*	22900	RG.002	085241	RG.037	085418	RG.072	085586
30 x 15 x 6*	22900	RG.004	085258	RG.039	085425	RG.074	085593
30 x 20 x 6*	22900	RG.006	085265	RG.041	085432	RG.076	085609
40 x 10 x 6	17100	RG.011	085272	RG.046	085449	RG.081	085616
40 x 15 x 6	17100	RG.012	085289	RG.047	085456	RG.082	085623
40 x 20 x 6	17100	RG.013	085296	RG.048	085463	RG.083	085630
40 x 30 x 6	17100	RG.015	085302	RG.050	085470	RG.085	085647
50 x 20 x 6	13700	RG.019	085319	RG.054	085487	RG.089	085654
50 x 30 x 6	13700	RG.021	085326	RG.056	085494	RG.091	085661
60 x 20 x 6	11400	RG.024	085333	RG.059	085500	RG.094	085678
60 x 30 x 6	11400	RG.026	085340	RG.061	085517	RG.096	085685
60 x 40 x 6	11400	RG.027	085357	RG.062	085524	RG.097	085692
60 x 50 x 6	11400	RG.028	085364	RG.063	085531	RG.098	085708
80 x 15 x 6	8500	RG.029	085371	RG.064	085548	RG.099	085715
80 x 30 x 6	8500	RG.032	085388	RG.067	085555	RG.102	085722
80 x 40 x 6	8500	RG.033	085395	RG.068	085562	RG.103	085739
80 x 50 x 6	8500	RG.034	085401	RG.069	085579	RG.104	085746

* A richiesta disponibili con gambo Ø 3 mm - Confezione: 10 pz.



imballo PG



imballo neutro

DISCO A LAMELLE RADIALI supporto in **NYLON**

358.00	ø 115 mm - foro ø 22 mm - grana 80	<input checked="" type="checkbox"/>	358000
358.10	ø 115 mm - foro ø 22 mm - grana 40	<input type="checkbox"/>	358109
358.15	ø 115 mm - foro ø 22 mm - grana 80	<input type="checkbox"/>	358154
358.20	ø 115 mm - foro ø 22 mm - grana 120	<input type="checkbox"/>	358208

DISCO A LAMELLE RADIALI supporto in **NYLON**

358.05	ø 180 mm - foro ø 22 mm - grana 80	<input checked="" type="checkbox"/>	358055
358.25	ø 180 mm - foro ø 22 mm - grana 40	<input type="checkbox"/>	358253
358.30	ø 180 mm - foro ø 22 mm - grana 80	<input type="checkbox"/>	358307
358.35	ø 180 mm - foro ø 22 mm - grana 120	<input type="checkbox"/>	358352

DISCO A LAMELLE RADIALI supporto in **FIBRA**

359.00	ø 115 mm - foro ø 22 mm - grana 80	<input checked="" type="checkbox"/>	359007
359.10	ø 115 mm - foro ø 22 mm - grana 40	<input type="checkbox"/>	359106
359.15	ø 115 mm - foro ø 22 mm - grana 80	<input type="checkbox"/>	359151
359.20	ø 115 mm - foro ø 22 mm - grana 120	<input type="checkbox"/>	359205

DISCO A LAMELLE RADIALI supporto in **FIBRA**

359.05	ø 180 mm - foro ø 22 mm - grana 80	<input checked="" type="checkbox"/>	359052
359.25	ø 180 mm - foro ø 22 mm - grana 40	<input type="checkbox"/>	359250
359.30	ø 180 mm - foro ø 22 mm - grana 80	<input type="checkbox"/>	359304
359.35	ø 180 mm - foro ø 22 mm - grana 120	<input type="checkbox"/>	359359

DISCO METALLICO AL TUNGSTENO - ø 125 mm

345.10	grana media	<input checked="" type="checkbox"/>	345109
345.20	grana fine	<input checked="" type="checkbox"/>	345208

MOLA AFFILATRICE per forbici, lame e coltelli

395.00	Ø 50 mm - gambo ch. 7 mm	10	395005
---------------	--------------------------	----	--------

**COTE** per affilare falci, coltelli e forbici

395.20	230 mm	10	395203
395.40	230 mm	10/100	395401

**MOLE SU PERNO IN CORINDONE ROSA**

Per metallo, vetro, ceramica e materie sintetiche

396.00	100 mole assortite - gambo Ø 6 mm in espositore self-service	1	396002
397.00	45 mole assortite - gambo Ø 3/6 mm in espositore	1	397009
397.20	48 mole assortite forma cilindrica - gambo Ø 3 mm in espositore	1	397207
397.30	48 mole assortite - gambo Ø 3 mm in espositore	1	397306
397.60	3 mole assortite per l'affilatura di seghe a catena - gambo Ø 3 mm	10	397603
398.00	5 mole assortite - gambo Ø 3 mm	10	398006
399.00	5 mole assortite - gambo Ø 6 mm	10	399003



**MOLA SU PERNO IN CORINDONE ROSA
FORMA CILINDRICA TIPO A**

2 x 6 x 3	MA.001	083681	12 x 20 x 6	MA.019	083865	30 x 25 x 6	MA.037	084046
3 x 6 x 3	MA.002	083698	12 x 30 x 6	MA.020	083872	30 x 30 x 6	MA.038	084053
4 x 8 x 3	MA.003	083704	15 x 15 x 6	MA.021	083889	30 x 40 x 6	MA.039	084060
5 x 10 x 3	MA.004	083711	15 x 20 x 6	MA.022	083896	35 x 20 x 6	MA.040	084077
6 x 10 x 3	MA.005	083728	15 x 25 x 6	MA.023	083902	35 x 25 x 6	MA.041	084084
8 x 10 x 3	MA.006	083735	15 x 30 x 6	MA.024	083919	35 x 35 x 6	MA.042	084091
10 x 10 x 3	MA.007	083742	15 x 40 x 6	MA.025	083926	40 x 20 x 6	MA.043	084107
12 x 12 x 3	MA.008	083759	20 x 15 x 6	MA.026	083933	40 x 25 x 6	MA.044	084114
15 x 15 x 3	MA.009	083766	20 x 20 x 6	MA.027	083940	40 x 30 x 6	MA.045	084121
4 x 8 x 6	MA.010	083773	20 x 25 x 6	MA.028	083957	40 x 40 x 6	MA.046	084138
5 x 10 x 6	MA.011	083780	20 x 30 x 6	MA.029	083964	50 x 25 x 6	MA.047	084145
6 x 10 x 6	MA.012	083797	20 x 40 x 6	MA.030	083971	50 x 30 x 6	MA.048	084152
8 x 10 x 6	MA.013	083803	25 x 15 x 6	MA.031	083988	50 x 40 x 6	MA.049	084169
10 x 10 x 6	MA.014	083810	25 x 20 x 6	MA.032	083995			
10 x 15 x 6	MA.015	083827	25 x 25 x 6	MA.033	084008			
10 x 20 x 6	MA.016	083834	25 x 30 x 6	MA.034	084015			
10 x 30 x 6	MA.017	083841	25 x 40 x 6	MA.035	084022			
12 x 12 x 6	MA.018	083858	30 x 20 x 6	MA.036	084039			

FORMA A PUNTA TIPO B

10 x 15 x 3	MB.001	084190	15 x 25 x 6	MB.004	084220	30 x 40 x 6	MB.007	084251
10 x 15 x 6	MB.002	084206	20 x 30 x 6	MB.005	084237			
10 x 20 x 6	MB.003	084213	25 x 30 x 6	MB.006	084244			

FORMA CILINDRICA CONICA TIPO C

6 x 8 x 3	MC.001	084268	10 x 15 x 6	MC.005	084305	20 x 30 x 6	MC.009	084343
8 x 12 x 3	MC.002	084275	10 x 20 x 6	MC.006	084312	20 x 40 x 6	MC.010	084350
8 x 12 x 6	MC.003	084282	15 x 20 x 6	MC.007	084329	25 x 40 x 6	MC.011	084367
8 x 20 x 6	MC.004	084299	15 x 25 x 6	MC.008	084336	30 x 40 x 6	MC.012	084374

FORMA PIATTA TIPO D

10 x 3,5 x 3	MD.001	084381	30 x 6 x 6	MD.008	084459	40 x 15 x 6	MD.015	084527
10 x 5 x 3	MD.002	084398	30 x 10 x 6	MD.009	084466	50 x 10 x 6	MD.016	084534
15 x 4 x 3	MD.003	084404	30 x 15 x 6	MD.010	084473	50 x 15 x 6	MD.017	084541
20 x 4 x 3	MD.004	084411	35 x 8 x 6	MD.011	084480	60 x 10 x 6	MD.018	084558
20 x 10 x 6	MD.005	084428	35 x 12 x 6	MD.012	084497	70 x 10 x 6	MD.019	084565
25 x 5 x 6	MD.006	084435	40 x 6 x 6	MD.013	084503			
25 x 10 x 6	MD.007	084442	40 x 10 x 6	MD.014	084510			

FORMA A SFERA TIPO E

4 x 3	ME.001	084572	10 x 3	ME.004	084602	20 x 6	ME.007	084633
6 x 3	ME.002	084589	10 x 6	ME.005	084619	25 x 6	ME.008	084640
8 x 3	ME.003	084596	15 x 6	ME.006	084626	30 x 6	ME.009	084657

∅ ·
spessore
· gambo

codice

EAN13
8011017

∅ ·
spessore
· gambo

codice

EAN13
8011017

∅ ·
spessore
· gambo

codice

EAN13
8011017

**TRONCATURA E
SMERIGLIATURA**

MOLA SU PERNO IN CORINDONE ROSA FORMA CONICA TIPO F

8 x 12 x 3	MF.001	084671	20 x 25 x 6	MF.004	084701	30 x 40 x 6	MF.007	084732
10 x 15 x 3	MF.002	084688	25 x 30 x 6	MF.005	084718			
10 x 15 x 6	MF.003	084695	30 x 30 x 6	MF.006	084725			

FORMA ARROTONDATA TIPO G

20 x 10 x 6	MG.001	084756	40 x 10 x 6	MG.003	084770			
30 x 10 x 6	MG.002	084763	40 x 20 x 6	MG.004	084787			

FORMA DOPPIO SMUSSO TIPO H

20 x 6 x 6	MH.001	084794	40 x 10 x 6	MH.003	084817			
30 x 10 x 6	MH.002	084800	50 x 10 x 6	MH.004	084824			

FORMA SEMISFERICA TIPO I

10 x 10 x 3	MI.001	084831	15 x 15 x 6	MI.004	084862	30 x 30 x 6	MI.007	084893
10 x 20 x 6	MI.002	084848	20 x 20 x 6	MI.005	084879			
12 x 12 x 6	MI.003	084855	25 x 25 x 6	MI.006	084886			

FORMA AD OGIVA TIPO L

6 x 10 x 3	ML.001	084916	10 x 15 x 6	ML.004	084947	18 x 32 x 6	ML.007	084978
8 x 10 x 3	ML.002	084923	12 x 20 x 6	ML.005	084954	20 x 40 x 6	ML.008	084985
8 x 10 x 6	ML.003	084930	15 x 20 x 6	ML.006	084961			

FORMA CONO ROVESCIATO TIPO M

10 x 20 x 3	MM.001	084992	20 x 20 x 6	MM.004	085029	30 x 30 x 6	MM.007	085050
12 x 20 x 6	MM.002	085005	20 x 30 x 6	MM.005	085036	40 x 20 x 6	MM.008	085067
15 x 20 x 6	MM.003	085012	30 x 20 x 6	MM.006	085043	40 x 30 x 6	MM.009	085074

FORMA TRONCO-CONICA TIPO N

8 x 10 x 3	MN.001	085081	12 x 20 x 6	MN.004	085111	25 x 40 x 6	MN.007	085142
8 x 15 x 3	MN.002	085098	15 x 25 x 6	MN.005	085128			
10 x 15 x 6	MN.003	085104	20 x 30 x 6	MN.006	085135			

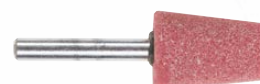
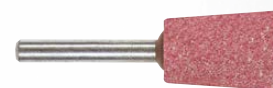
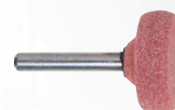

Confezione: **10** pz.



imballo PG



imballo neutro

MOLA ABRASIVA IN CORINDONE GRIGIO

400.00	Ø 75 x 10 mm - foro Ø 10 mm	<input type="checkbox"/>	400006
402.00	Ø 75 x 10 mm - foro Ø 13 mm	<input type="checkbox"/>	402000
403.00	Ø 75 x 10 mm - foro Ø 13 mm - CARBURO DI SILICIO	<input type="checkbox"/>	403007
404.00	Ø 100 x 12 mm - foro Ø 13 mm	<input type="checkbox"/>	404004
404.50	Ø 125 x 15 mm - foro Ø 16 mm	<input type="checkbox"/>	404509
405.00	Ø 150 x 20 mm - foro Ø 16 mm	<input type="checkbox"/>	405001

MOLA TRONCATRICE per metallo

406.00	Ø 125 x 2,5 mm - foro Ø 13 mm	<input type="checkbox"/>	406008
406.95	Ø 115 x 1,0 mm - foro Ø 22 mm	<input type="checkbox"/>	406954
407.00	Ø 115 x 1,6 mm - foro Ø 22 mm	<input type="checkbox"/>	407005
407.05	Ø 115 x 1,6 mm - foro Ø 22 mm	<input type="checkbox"/>	407050

MOLA TRONCATRICE per marmo

408.00	Ø 125 x 2,5 mm - foro Ø 13 mm	<input type="checkbox"/>	408002
409.00	Ø 115 x 1,6 mm - foro Ø 22 mm	<input type="checkbox"/>	409009
409.05	Ø 115 x 1,6 mm - foro Ø 22 mm	<input type="checkbox"/>	409054

MOLA RESINOIDE A CENTRO DEPRESSO per metallo

100 x 3,0 x 16	411.05	-	50	411057
100 x 4,8 x 16	-	412.05	50	412054
115 x 3,2 x 22	413.00	-	10	413006
115 x 3,2 x 22	413.05	-	10	413051
115 x 6,4 x 22	-	414.00	10	414003
115 x 6,4 x 22	-	414.05	10	414058
125 x 3,0 x 22	415.05	-	50	415055
125 x 6,4 x 22	-	416.05	50	416052
150 x 3,2 x 22	416.60	-	25	416601
150 x 6,4 x 22	-	416.80	25	416809
178 x 3,2 x 22	417.00	-	25	417004
178 x 6,4 x 22	-	417.30	25	417301
230 x 3,2 x 22	418.00	-	25	418001
230 x 6,4 x 22	-	418.30	25	418308



MOLA RESINOIDE A CENTRO DEPRESSO per marmo e laterizi

100 x 3,0 x 16	411.55	-	50	411552
100 x 4,8 x 16	-	412.55	50	412559
115 x 3,2 x 22	413.50	-	10	413501
115 x 3,2 x 22	413.55	-	10	413556
115 x 6,4 x 22	-	414.50	10	414508
115 x 6,4 x 22	-	414.55	10	414553
125 x 3,0 x 22	415.55	-	50	415550
125 x 6,4 x 22	-	416.50	25	416502
150 x 3,2 x 22	416.70	-	25	416700
150 x 6,4 x 22	-	416.90	25	416908
178 x 3,2 x 22	417.10	-	25	417103
178 x 6,4 x 22	-	417.50	25	417509
230 x 3,2 x 22	418.10	-	25	418100
230 x 6,4 x 22	-	418.50	25	418506



MOLA AD IMPASTO CERAMICO
A96 CORINDONE GRIGIO
**C49 VERDE
CARBURO
DI SILICIO**

dimensioni Ø x spessore x foro	grane						grana	
	24	36	46	60	80	100		
75 x 10 x 10				A96.053	A96.078	A96.102		C49.010
75 x 12 x 13				A96.054	A96.079	A96.103		C49.011
100 x 10 x 13				A96.055	A96.080	A96.104		
100 x 13 x 13		A96.204	A96.209	A96.056	A96.214	A96.105		C49.012
100 x 15 x 13	A96.199	A96.205	A96.210	A96.057	A96.082	A96.106		C49.013
100 x 20 x 13	A96.200	A96.206	A96.211	A96.058	A96.083	A96.107		C49.050
125 x 13 x 16		A96.157	A96.166	A96.175	A96.185	A96.191		
125 x 15 x 16	A96.149	A96.158	A96.167	A96.176	A96.186	A96.192		C49.034
125 x 20 x 16	A96.150	A96.127	A96.168	A96.177	A96.187	A96.193		C49.035
125 x 25 x 16	A96.151	A96.160	A96.169	A96.178	A96.188	A96.194		
150 x 16 x 16	A96.001	A96.019	A96.038	A96.063	A96.088	A96.112		C49.051
150 x 20 x 16	A96.002	A96.020	A96.039	A96.064	A96.089	A96.113		C49.016
150 x 20 x 32		A96.207		A96.212				
150 x 25 x 16	A96.003	A96.021	A96.040	A96.065	A96.090	A96.114		C49.017
150 x 30 x 16	A96.004	A96.022	A96.041	A96.066	A96.091	A96.115		
175 x 20 x 20	A96.005	A96.023	A96.042	A96.067	A96.092	A96.116		C49.018
175 x 25 x 20	A96.006	A96.024	A96.043	A96.068	A96.093	A96.117		C49.052
200 x 20 x 20	A96.008	A96.026	A96.045	A96.070	A96.095	A96.119		C49.019
200 x 20 x 32		A96.208		A96.213				
200 x 25 x 20	A96.009	A96.027	A96.046	A96.071	A96.096	A96.120		C49.020
200 x 30 x 20	A96.010	A96.028	A96.047	A96.072	A96.097	A96.121		C49.053
250 x 25 x 25	A96.011	A96.029	A96.048	A96.073	A96.098	A96.122		C49.054
250 x 30 x 25	A96.012	A96.030	A96.049	A96.074	A96.099	A96.123		C49.055
300 x 30 x 30	A96.013	A96.031	A96.050	A96.075	A96.100	A96.124		
300 x 35 x 30	A96.147	A96.155	A96.164	A96.173	A96.182			
300 x 40 x 30	A96.014	A96.032	A96.051	A96.076	A96.101			
400 x 50 x 40	A96.148	A96.033	A96.052	A96.077	A96.184			

 Confezione: pz.

 imballo PG imballo neutro

MOLA CON PROFILO «C» PER AFFILATURA SEGHE - grana 80

dimensioni	A96 grigio		A99 bianco		dimensioni	A96 grigio		A99 bianco	
∅ x spessore x foro	codice		codice		∅ x spessore x foro	codice		codice	
125 x 6 x 16	A96C.01		A99C.01		175 x 8 x 20	A96C.08		A99C.08	
125 x 7 x 16	A96C.02		A99C.02		175 x 10 x 20	A96C.09		A99C.09	
125 x 8 x 16	A96C.03		A99C.03		200 x 6 x 20	A96C.10		A99C.10	
150 x 6 x 16	A96C.04		A99C.04		200 x 8 x 20	A96C.11		A99C.11	
150 x 7 x 16	A96C.05		A99C.05		200 x 10 x 20	A96C.12		A99C.12	
150 x 8 x 16	A96C.06		A99C.06		200 x 12 x 20	A96C.14			
150 x 10 x 16	A96C.13		A99C.13		250 x 10 x 25	A96C.15			
175 x 6 x 20	A96C.07		A99C.07		250 x 13 x 25	A96C.16			

BASTONCINO A RAVVIVAMOLA C48 20T in carburo di silicio nero

dimensioni	codice
150 x 20	C48.01
200 x 20	C48.02
200 x 25	C48.03





 Confezione: **8** pz.

PIETRA A DOPPIA GRANA
per affilatura ad olio di utensili

dimensioni	C49 verde grana 120/400		A99 rosa grana 150/320	
	lung. x larg. x spess.	codice	codice	
125 x 50 x 20	DG.01	DG.03		
150 x 50 x 25	DG.02	DG.04		

 Confezione: **4** pz.

LIMA ABRASIVA in corindone rosa

dimensioni	grana 80		grana 120		grana 220		FORMA
	codice		codice		codice		
100 x 13	LTR.001		LTR.004		LTR.007		 triangolare
150 x 16	LTR.002		LTR.005		LTR.008		
200 x 20	LTR.003		LTR.006		LTR.009		
100 x 13	LTO.001		LTO.004		LTO.007		 mezza-tonda
150 x 16	LTO.002		LTO.005		LTO.008		
200 x 20	LTO.003		LTO.006		LTO.009		
100 x 13	LQU.001		LQU.004		LQU.007		 quadrata
150 x 16	LQU.002		LQU.005		LQU.008		
200 x 20	LQU.003		LQU.006		LQU.009		

 Confezione: **10** pz.

 imballo PG

 imballo neutro

DISCO DIAMANTATO UNIVERSALE TURBO DA TAGLIO

Per tagliare cemento armato, klinker, mezzi mattoni, granito

419.60	Ø 115 mm - foro Ø 22 mm	1	419602
419.65	Ø 230 mm - foro Ø 22 mm	1	419657

DISCO DIAMANTATO SEGMENTATO DA TAGLIO

Per tagliare laterizio, pietre per muratura naturali, pietre per pavimentazioni, piastrelle per marciapiedi

419.70	Ø 115 mm - foro Ø 22 mm	1	419701
419.75	Ø 230 mm - foro Ø 22 mm	1	419756

DISCO DIAMANTATO A CORONA CONTINUA DA TAGLIO

Per tagliare mattonelle, piastrelle in ceramica, mezzi mattoni, marmo

419.80	Ø 115 mm - foro Ø 22 mm	1	419800
419.85	Ø 230 mm - foro Ø 22 mm	1	419855

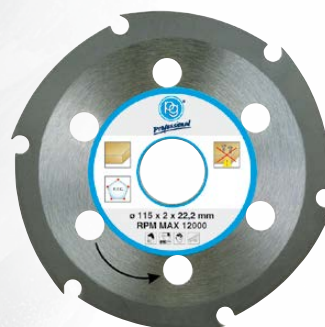
DISCO DA TAGLIO

Per fresare, tagliare e smussare il legno e lavorare PVC e altri materiali plastici

419.90	Ø 115 mm - foro Ø 22 mm	5	419909
419.95	Ø 230 mm - foro Ø 22 mm	1	419954

FRESA SAGOMATA - gambo \varnothing 8 mm

360.00	\varnothing 35 mm per profilo mezzo tondo interno 45°		5	360003
361.00	\varnothing 35 mm per profilo mezzo tondo esterno 45°		5	361000
362.00	\varnothing 35 mm per profilo concavo		5	362007
363.00	\varnothing 35 mm per profilo convesso		5	363004
364.00	\varnothing 25 x 22 mm cilindrica per levigare		5	364001
364.50	\varnothing 25 x 22 mm per profilo tondo		5	364506
365.00	\varnothing 35 mm conica 45°		5	365008
366.00	\varnothing 35 x 5 mm per scanalatura		5	366005
367.00	\varnothing 30 x 22 mm doppia battuta per incastri		5	367002
368.00	\varnothing 30 x 1,5 mm per intagli		5	368009
369.00	\varnothing 30 x 2,5 mm per intagli		5	369006
370.00	\varnothing 45 x 1,5 mm circolare a sega		5	370002
372.00	\varnothing 6 mm a dito per mortasare		5	372006

**FRESATRICE UNIVERSALE** per l'utilizzo di tutte le frese sagomate

373.00	fresatrice regolabile completa di fresa \varnothing 45 mm - CE	1	373003
---------------	--	---	--------

**PUNTA-FRESA REGOLABILE PER SVASARE** con arresto di profondità

374.03	\varnothing 3 mm	10	374031
374.04	\varnothing 4 mm	10	374048
374.05	\varnothing 5 mm	10	374055
374.06	\varnothing 6 mm	10	374062



FRESA PER SVASARE - gambo ø 6 mm

375.00	ø 6 mm	10	375007
376.00	ø 12 mm	10	376004
377.00	ø 16 mm	10	377001
378.00	ø 19 mm	10	378008

**FRESA PER SVASARE AD OMBRELLO - gambo ø 5 mm**

379.00	ø 13 mm	10	379005
---------------	---------	----	--------

**FRESA PER SVASARE - gambo ch. 1/4**

451.10	ø 10 mm	5	451107
451.20	ø 13 mm	5	451206
451.30	ø 16 mm	5	451305

**FRESA PER SVASARE MANUALE**

451.00	ø 12 mm - a 5 tagli	10	451008
---------------	---------------------	----	--------

**FRESA PER CERNIERA - gambo ø 8 mm**

379.50	ø 20 mm	10	379500
380.00	ø 26 mm	10	380001
381.00	ø 30 mm	10	381008
382.00	ø 35 mm	10	382005
383.00	ø 38 mm	10	383002

**FRESA PER CERNIERA IN METALLO DURO - gambo ø 8 mm**

384.00	ø 26 mm	5	384009
384.10	ø 30 mm	5	384108
384.20	ø 35 mm	5	384207



MECCHIA per legno - gambo \varnothing 6 mm

384.50	\varnothing 6 mm	10	384504
385.00	\varnothing 8 mm	10	385006
386.00	\varnothing 10 mm	10	386003
387.00	\varnothing 12 mm	10	387000
388.00	\varnothing 14 mm	10	388007
389.00	\varnothing 16 mm	10	389004
390.00	\varnothing 18 mm	10	390000
391.00	\varnothing 20 mm	10	391007
392.00	\varnothing 22 mm	10	392004
392.50	\varnothing 24 mm	10	392509
393.00	\varnothing 25 mm	10	393001
393.20	\varnothing 26 mm	10	393209
393.40	\varnothing 28 mm	10	393407
393.60	\varnothing 30 mm	10	393605
394.00	\varnothing 32 mm	10	394008
394.20	\varnothing 35 mm	10	394206
394.40	\varnothing 38 mm	10	394404

**MECCHIA REGOLABILE** per legno

394.70	\varnothing 15/45 mm - gambo \varnothing 6 mm	2	394701
394.80	\varnothing 22/76 mm - gambo \varnothing 10 mm	2	394800

**PROLUNGA PER MECCHIE** - gambo \varnothing 6 mm

394.84	150 mm	5	394848
394.86	300 mm	5	394862



PUNTA FORSTNER - DIN 7483

 lunghezza **90 mm** - gambo \varnothing **8 mm**

12.010	\varnothing 10 mm	1	120102
12.012	\varnothing 12 mm	1	120126
12.014	\varnothing 14 mm	1	120140
12.015	\varnothing 15 mm	1	120157
12.016	\varnothing 16 mm	1	120164
12.018	\varnothing 18 mm	1	120188
12.020	\varnothing 20 mm	1	120201
12.022	\varnothing 22 mm	1	120225
12.024	\varnothing 24 mm	1	120249
12.025	\varnothing 25 mm	1	120256
12.026	\varnothing 26 mm	1	120263
12.028	\varnothing 28 mm	1	120287
12.030	\varnothing 30 mm	1	120300
12.032	\varnothing 32 mm - gambo \varnothing 10 mm	1	120324
12.034	\varnothing 34 mm - gambo \varnothing 10 mm	1	120348
12.035	\varnothing 35 mm - gambo \varnothing 10 mm	1	120355
12.036	\varnothing 36 mm - gambo \varnothing 10 mm	1	120362
12.040	\varnothing 40 mm - gambo \varnothing 10 mm	1	120409
12.045	\varnothing 45 mm - gambo \varnothing 10 mm	1	120454
12.050	\varnothing 50 mm - gambo \varnothing 10 mm	1	120508

LIMA ROTATIVA per metallo - gambo \varnothing 6 mm

420.00	lima cilindrica	10	420004
422.00	lima conica	10	422008
424.00	lima cilindrica bombata	10	424002
426.00	lima sferica	10	426006
445.00	punta - fresa HSS \varnothing 6 x 85 mm	10	445007

**LIMA ROTATIVA** per metallo - gambo ch. 1/4

445.20	lima conica	5	445205
445.30	lima cilindrica bombata	5	445304

**RASPA ROTATIVA** per legno - gambo \varnothing 6 mm

430.00	raspa cilindrica	10	430003
432.00	raspa conica	10	432007
434.00	raspa sferica	10	434001
436.00	raspa conica bombata	10	436005
438.00	fresa per svasare	10	438009
440.00	punta - raspa \varnothing 6 x 90 mm	10	440002

**RASPA ROTATIVA** per legno - gambo ch. 1/4

440.20	raspa conica	5	440200
440.40	raspa cilindrica bombata	5	440408

**ASSORTIMENTO FRESE E RASPE** - gambo \varnothing 6 mm

446.00	3 mini frese e raspe assortite	10	446004
447.00	6 frese e raspe assortite	5	447001



FRESA - RASPA ROTATIVA per legno - gambo \varnothing 6 mm

448.00	\varnothing 10/15 mm	10	448008
448.10	\varnothing 15/20 mm	10	448107
448.20	\varnothing 20/25 mm	10	448206

LIMA - RASPA per metallo e legno

449.06	lunghezza 6" - 150 mm	10	449067
449.08	lunghezza 8" - 200 mm	10	449081

LIME per metallo - lunghezza 4" - 100 mm

449.20	6 lime forma piatta parallela - piatta a punta - mezzatonda - tonda - a triangolo - quadra	5	449203
---------------	--	---	--------

LIME TONDE per seghe a catena - lunghezza 8" - 200 mm

449.40	2 lime \varnothing 5/32" - 4,0 mm	10	449401
449.45	12 lime \varnothing 5/32" - 4,0 mm	2	449456
449.50	2 lime \varnothing 3/16" - 4,8 mm	10	449500
449.55	12 lime \varnothing 3/16" - 4,8 mm	2	449555
449.60	2 lime \varnothing 7/32" - 5,6 mm	10	449609
449.65	12 lime \varnothing 7/32" - 5,6 mm	2	449654

PORTA INSERTI MAGNETICOPer inserti con attacco esagonale **1/4**

452.00	gambo ch. 1/4 - lunghezza 60 mm	10	452005
452.05	a rilascio rapido - gambo ch. 1/4 - lunghezza 60 mm	5	452050
452.10	con regolazione di profondità - gambo ch. 1/4 - lunghezza 60 mm - per cartongesso	5	452104
452.15	flessibile - gambo ch. 1/4 - lunghezza 190 mm	5	452159
452.20	attacco SDS plus - lunghezza 75 mm	5	452203

**AVVITATORE A SQUADRA**

452.30	con porta inserti esagonale 1/4	5	452302
---------------	--	---	--------

**INSERTI PER VITI TORX - lunghezza 25 mm**

452.40	2 inserti T10	10	452401
452.50	2 inserti T15	10	452500
452.60	2 inserti T20	10	452609
452.70	2 inserti T25	10	452708
452.80	2 inserti T30	10	452807
452.90	2 inserti T40	10	452906

**INSERTI AL TITANIO PER VITI TORX - lunghezza 25 mm**

452.92	2 inserti T10	5	452920
452.93	2 inserti T15	5	452937
452.94	2 inserti T20	5	452944
452.95	2 inserti T25	5	452951
452.96	2 inserti T30	5	452968
452.97	2 inserti T40	5	452975



imballo PG



imballo neutro

INSERTI PER VITI A CAVA ESAGONALE - lunghezza 25 mm

453.00	2 inserti 2 mm	10	453002
453.10	2 inserti 2,5 mm	10	453101
453.20	2 inserti 3 mm	10	453200
453.30	2 inserti 4 mm	10	453309
453.40	2 inserti 5 mm	10	453408
453.50	2 inserti 6 mm	10	453507

INSERTI PHILLIPS - lunghezza 25 mm

454.00	2 inserti n. 1	10	454009
455.00	2 inserti n. 2	10	455006
456.00	2 inserti n. 3	10	456003
456.20	1 inserto n. 4	10	456201

INSERTI PHILLIPS AL TITANIO - lunghezza 25 mm

456.50	2 inserti n. 1	5	456508
456.52	2 inserti n. 2	5	456522
456.54	2 inserti n. 3	5	456546

INSERTI TAGLIO - lunghezza 25 mm

457.00	2 inserti 0,8 x 4 mm	10	457000
458.00	2 inserti 0,8 x 5 mm	10	458007
459.00	2 inserti 1,0 x 6 mm	10	459004
459.20	2 inserti 1,2 x 7,2 mm	10	459202
459.40	2 inserti 1,6 x 8 mm	10	459400

INSERTI TAGLIO AL TITANIO - lunghezza 25 mm

459.50	2 inserti 0,8 x 4 mm	5	459509
459.52	2 inserti 0,8 x 5 mm	5	459523
459.54	2 inserti 1,0 x 6 mm	5	459547

INSERTI POZIDRIV - lunghezza 25 mm

459.90	2 inserti n. 0	10	459905
460.00	2 inserti n. 1	10	460000
460.10	2 inserti n. 2	10	460109
460.20	2 inserti n. 3	10	460208
460.30	1 inserto n. 4	10	460307

**INSERTI POZIDRIV AL TITANIO - lunghezza 25 mm**

460.50	2 inserti n. 0	5	460505
460.52	2 inserti n. 1	5	460529
460.54	2 inserti n. 2	5	460543
460.56	2 inserti n. 3	5	460567

**INSERTO A DOPPIO INTAGLIO - lunghezza 60 mm**

461.00	taglio 0,8 x 4 mm + Phillips n. 1	10	461007
462.00	taglio 0,8 x 5 mm + Phillips n. 2	10	462004
462.50	taglio 1,2 x 7,2 mm + Phillips n. 3	10	462509

**KIT INSERTI ASSORTITI**

463.00	7 pezzi: porta inserti magnetico + Phillips 1 - 2 + Pozidriv 1 - 2 + taglio 4 - 5 mm	5	463001
463.50	7 pezzi: porta inserti magnetico + Torx T10 - T15 - T20 - T25 - T30 - T40	5	463506
464.00	10 pezzi: porta inserti magnetico + Phillips 1 - 2 - 3 + Pozidriv 1 - 2 - 3 + taglio 4 - 5 - 6 mm	5	464008
PG32A	32 pezzi: porta inserti magnetico ad attacco rapido + Phillips 1 - 2 - 2 - 3 + Pozidriv 1 - 2 - 2 - 3 + taglio 3 - 4 - 5 - 6 mm + esagonali 3 - 4 - 5 - 6 mm + Torx T10 - T15 - T20 - T25 - T27 - T30 - T40 + Torx foro T10 - T15 - T20 - T25 - T27 - T30 - T40 + adattatore attacco 1/4" esagonale a 1/4" quadro	1	071046



SPAZZOLA CIRCOLARE in filo d'ottone - gambo \varnothing 6 mm

490.00	\varnothing 75 mm	<input checked="" type="checkbox"/>	10	490007
---------------	---------------------	-------------------------------------	----	--------

SPAZZOLA A TAZZA in filo d'ottone - gambo \varnothing 6 mm

495.00	\varnothing 50 mm	<input checked="" type="checkbox"/>	10	495002
---------------	---------------------	-------------------------------------	----	--------

SPAZZOLA CIRCOLARE CONICA in filo d'acciaio - gambo \varnothing 6 mm

466.00	\varnothing 90 mm	<input checked="" type="checkbox"/>	10	466002
466.01	20 spazzole art. 466.00 sfuse	<input type="checkbox"/>	1	466019

SPAZZOLA CIRCOLARE CONICA in filo d'acciaio - foro M14

467.00	\varnothing 90 mm	<input checked="" type="checkbox"/>	10	467009
467.01	20 spazzole art. 467.00 sfuse	<input type="checkbox"/>	1	467016
468.00	\varnothing 120 mm	<input checked="" type="checkbox"/>	10	468006
468.01	20 spazzole art. 468.00 sfuse	<input type="checkbox"/>	1	468013
468.20	\varnothing 150 mm	<input checked="" type="checkbox"/>	5	468204
468.30	\varnothing 100 mm - a mazzetti ritorti	<input checked="" type="checkbox"/>	5	468303
468.35	\varnothing 120 mm - a mazzetti ritorti	<input checked="" type="checkbox"/>	5	468358
468.40	\varnothing 150 mm - a mazzetti ritorti	<input checked="" type="checkbox"/>	5	468402



SPAZZOLA CIRCOLARE in filo d'acciaio - gambo \varnothing 6 mm

468.50	\varnothing 40 mm	10	468501
468.51	20 spazzole art. 468.50 sfuse	1	468518
469.00	\varnothing 50 mm	10	469003
469.01	20 spazzole art. 469.00 sfuse	1	469010
470.00	\varnothing 75 mm	10	470009
470.01	20 spazzole art. 470.00 sfuse	1	470016
470.50	\varnothing 75 mm - doppio spessore	10	470504
475.00	\varnothing 100 mm	10	475004
475.01	20 spazzole art. 475.00 sfuse	1	475011
475.50	\varnothing 100 mm - doppio spessore	10	475509
475.65	\varnothing 75 mm - a mazzetti ritorti	5	475653
475.70	\varnothing 100 mm - a mazzetti ritorti	5	475707

**SPAZZOLA CIRCOLARE** in filo d'acciaio

485.80	\varnothing 75 mm - foro \varnothing 13 mm	10	485805
486.00	\varnothing 100 mm - foro \varnothing 13 mm	10	486000
487.00	\varnothing 120 mm - foro \varnothing 16 mm	10	487007
488.00	\varnothing 150 mm - foro \varnothing 32/20/16 mm	10	488004
489.00	\varnothing 200 mm - foro \varnothing 32/20/16 mm spessore 20 mm	1	489001
489.50	\varnothing 200 mm - foro \varnothing 32/20/16 mm spessore 40 mm	1	489506



imballo PG



imballo neutro

MINI SPAZZOLE in filo d'acciaio - gambo ø **2,35** mm

476.00	3 mini spazzole assortite - ø 5 - 12 - 21 mm	<input checked="" type="checkbox"/>	10	476001
---------------	--	-------------------------------------	----	--------

SPAZZOLA A PENNELLO in filo d'acciaio - gambo ø **6** mm

477.00	ø 16 mm	<input checked="" type="checkbox"/>	10	477008
477.01	20 spazzole art. 477.00 sfuse	<input type="checkbox"/>	1	477015
478.00	ø 25 mm	<input checked="" type="checkbox"/>	10	478005
478.01	20 spazzole art. 478.00 sfuse	<input type="checkbox"/>	1	478012

SPAZZOLA A FUNGO in filo d'acciaio - gambo ø **6** mm

478.20	ø 30 mm	<input checked="" type="checkbox"/>	10	478203
478.40	ø 40 mm	<input checked="" type="checkbox"/>	10	478401

SPAZZOLA A SCOVOLO in filo d'acciaio - gambo ø **6** mm

479.00	ø 28 mm	<input checked="" type="checkbox"/>	10	479002
479.01	20 spazzole art. 479.00 sfuse	<input type="checkbox"/>	1	479019

SPAZZOLA A TAZZA in filo d'acciaio - gambo \varnothing 6 mm

480.00	\varnothing 50 mm	10	480008
480.01	20 spazzole art. 480.00 sfuse	1	480015
485.00	\varnothing 70 mm	10	485003
485.01	20 spazzole art. 485.00 sfuse	1	485010
485.20	\varnothing 85 mm	10	485201
485.21	20 spazzole art. 485.20 sfuse	1	485218

**SPAZZOLA A TAZZA** in filo d'acciaio - foro **M14**

485.30	\varnothing 60 mm	10	485300
485.31	20 spazzole art. 485.30 sfuse	1	485317
485.40	\varnothing 85 mm	10	485409
485.41	20 spazzole art. 485.40 sfuse	1	485416
485.50	\varnothing 100 mm	5	485508
485.51	10 spazzole art. 485.50 sfuse	1	485515
485.60	\varnothing 120 mm	5	485607
485.61	5 spazzole art. 485.60 sfuse	1	485614
485.65	\varnothing 150 mm	5	485652
485.70	\varnothing 65 mm - a mazzetti ritorti	5	485706
485.75	\varnothing 85 mm - a mazzetti ritorti	5	485751
485.76	\varnothing 100 mm - a mazzetti ritorti	1	485768
485.77	\varnothing 120 mm - a mazzetti ritorti	1	485775



SPAZZOLA CIRCOLARE in nylon abrasivo - gambo ø 6 mm



497.05	ø 75 mm - arancio grana 80	5	497051
497.10	ø 75 mm - blu grana 150	5	497105
497.15	ø 100 mm - arancio grana 80	5	497150
497.20	ø 100 mm - blu grana 150	5	497204

SPAZZOLA A TAZZA in nylon abrasivo - gambo ø 6 mm

497.25	ø 50 mm - arancio grana 80	5	497259
497.30	ø 50 mm - blu grana 150	5	497303
497.35	ø 70 mm - arancio grana 80	5	497358
497.40	ø 70 mm - blu grana 150	5	497402

SPAZZOLA A PENNELLO in nylon abrasivo - gambo ø 6 mm

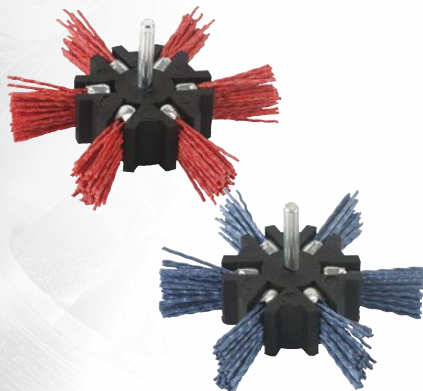
497.45	ø 25 mm - arancio grana 80	5	497457
497.50	ø 25 mm - blu grana 150	5	497501

SPAZZOLA A VENTAGLIO in nylon abrasivo - gambo ø 6 mm

497.55	ø 100 mm - arancio grana 80	5	497556
497.60	ø 100 mm - blu grana 150	5	497600



ASSORTIMENTO SPAZZOLE ACCIAIO in espositore self-service

496.00	40 spazzole filo d'acciaio: 10 art. 469.00 - 10 art. 470.00 10 art. 480.00 - 10 art. 485.00	1	496009
---------------	--	----------	--------



ASSORTIMENTO SPAZZOLE NYLON in espositore self-service

496.50	30 spazzole in nylon abrasivo: 3 spazzole per tipo art. 497.05 - 10 - 15 - 20 - 25 - 30 - 35 - 40 - 45 - 50	1	496504
---------------	---	----------	--------

MINI SPAZZOLE MANUALI

496.82	spazzola in filo d'acciaio	12	496825
496.85	spazzola in filo di ottone	12	496856
496.88	spazzola in filo di nylon abrasivo	12	496887





SPAZZOLA A MANO UNIVERSALE in filo d'acciaio

497.00 spazzola in espositore self-service

24

497006



KIT 5 SPAZZOLE in filo d'acciaio

497.02 spazzola circolare \varnothing 50 mm + spazzola circolare \varnothing 75 mm + spazzola a tazza \varnothing 50 mm + spazzola a tazza \varnothing 70 mm + spazzola a pennello \varnothing 16 mm

3

497020



KIT 4 SPAZZOLE in filo d'acciaio

497.04 spazzola circolare \varnothing 75 mm + spazzola a tazza \varnothing 50 mm + spazzola a pennello \varnothing 25 mm + spazzola a mano

10

497044



Totale referenze 15		Totale pezzi 134		
Professional				
10x 476.00	10x 469.00	10x 477.00	10x 478.00	10x 479.00
10x 470.00	10x 475.00	10x 480.00		
10x 485.00	10x 485.20	10x 485.40		
7x 485.30		7x 485.70		
5x 485.50		5x 485.75		

ESPOSITORE DA BANCO

ESPO.S1	- altezza 80 cm	1	087450
	- larghezza 37 cm		
	- profondità 32 cm		



Totale referenze 8		Totale pezzi 94	
Professional			
10x 478.00	10x 479.00	10x 470.00	
10x 475.00	10x 485.00		
10x 485.20	10x 485.40		
24x 497.00			

ESPOSITORE DA BANCO

ESPO.S2	- altezza 70 cm	1	087702
	- larghezza 28 cm		
	- profondità 34 cm		

OCCHIALI DI PROTEZIONE

498.00	per saldatura - CE - EN 166	5	498003
498.50	per saldatura - doppia lente - CE - EN 166	5	498508
498.60	per saldatura - professionali - doppia lente - CE - EN 166	1	498607

OCCHIALI DI PROTEZIONE

500.00	professionali - con ripari laterali - CE - EN 166	1	500003
500.25	professionali - sovrapponibili agli occhiali da vista - con ripari laterali - CE - EN 166	1	500256
500.35	professionali - con ripari laterali - CE - EN 166	1	500355

OCCHIALI DI PROTEZIONE

501.00	tipo morbido - modello hobby - non DPI	5	501000
501.20	tipo morbido - con microfori - CE - EN 166	1	501208
501.40	tipo morbido - con valvole di aerazione - CE - EN 166	1	501406
501.60	tipo morbido - professionali - con valvole di aerazione maggiore protezione - CE - EN 166	1	501604

MASCHERA PROTETTIVA ANTIPOLVERE

502.00	5 maschere - non DPI	10	502007
502.50	50 maschere - non DPI	1	502502
502.60	2 maschere contro polveri non tossiche - CE - EN 149 FFP1	10	502601
502.70	2 maschere a carboni attivi con valvola di espirazione, contro polveri non tossiche, odori e polveri organiche - CE - EN 149 FFP1	5	502700
503.00	1 maschera rinforzata - non DPI	10	503004

**RESPIRATORE E FILTRI DI RICAMBIO**

504.00	respiratore con filtro antipolvere - non DPI	5	504001
504.20	filtro antipolvere - non DPI	5	504209
504.40	filtro chimico - non DPI	5	504407

**RESPIRATORE E FILTRI DI RICAMBIO**

504.50	respiratore con filtro per vapori organici, vernici e solventi A1 - CE - EN 140/141	1	504506
504.55	filtro per vapori organici, vernici e solventi A1 - CE - EN 140/141	2	504551
504.58	filtro per polveri fini e aerosol P3 - CE - EN 140/143	2	504582



RESPIRATORE CON 2 FILTRI E FILTRI DI RICAMBIO

504.70	respiratore con 2 filtri per vapori organici, vernici e solventi A1 - CE - EN 140/141	1	504704
504.75	filtro per vapori organici, vernici e solventi A1 - CE - EN 140/141	2	504759
504.78	filtro per polveri fini e aerosol P3 - CE - EN 140/143	2	504780

CUFFIA ANTIRUMORE

505.00	modello hobby - non DPI	5	505008
505.20	livello di attenuazione medio - alto - CE - EN 352-1	1	505206
505.40	livello di attenuazione alto - professionale - CE - EN 352-1	1	505404

KIT ANTI-INFORTUNISTICA - CE

505.50	occhiali di protezione EN166 + maschera antipolvere EN149 + tappi auricolari EN352-2 + cuffia antirumore EN352-1	1	505503
---------------	--	----------	--------

TAPPI AURICOLARI

505.80	3 paia in schiuma poliuretana - CE - EN 352-3	10	505800
505.83	5 paia in bimatereale - alto comfort - CE - EN 352-3	10	505831
505.86	1 paio a tripla flangia con cordoncino - CE - EN 352-2	10	505862



GUANTI IN NITRILE SPESSORATI

Uso professionale - CE - EN388 - EN455 1 & 2

506.10	Taglia M	50 guanti monouso: - ipoallergenici - non contengono lattice	1	506104
506.11	Taglia L	- con polveri vegetali antisudore - bordo rinforzato	1	506111
506.12	Taglia XL	- ambidestri - polso lungo	1	506128



GUANTI IN NITRILE

Uso professionale - CE - EN455 1 & 2

506.15	Taglia M	100 guanti monouso: - ipoallergenici - non contengono lattice	1	506159
506.16	Taglia L	- con polveri vegetali antisudore - bordo rinforzato	1	506166
506.17	Taglia XL	- ambidestri	1	506173

GINOCCHIERE IN GOMMA

506.50	ginocchiere in gomma	1	506500
---------------	----------------------	---	--------



ELMETTO DI PROTEZIONE

506.60	elmetto protettivo - CE - EN 397	1	506609
---------------	----------------------------------	---	--------



MISCELATORE

Per malta, cemento, intonaco, vernici, colle e altri liquidi

507.00	Ø 80 x 400 mm - gambo ch. 8	5	507002
508.00	Ø 100 x 500 mm - gambo ch. 8	2	508009
509.00	Ø 120 x 600 mm - gambo ch. 10	2	509006

MISCELATORE

Per malta, cemento, intonaco, vernici, colle e altri liquidi

509.40	Ø 130 x 600 mm - gambo ch. 10	2	509402
---------------	-------------------------------	---	--------

MISCELATORE

Per vernici, colori, smalti, colle e altri liquidi

510.00	Ø 60 x 350 mm - gambo Ø 6 mm	10	510002
511.00	Ø 60 x 400 mm - gambo ch. 8	5	511009
512.00	Ø 80 x 400 mm - gambo ch. 8	5	512006
513.00	Ø 100 x 600 mm - gambo ch. 10	2	513003
514.00	Ø 120 x 600 mm - gambo ch. 12	2	514000
514.10	Ø 125 x 600 mm - gambo ch. 10 - doppia elica	2	514109

COLTELLO PROFESSIONALE

566.00	per antinfortunistica, con rientro automatico della lama a fine lavoro	4	566009
566.05	permette di effettuare il cambio della lama senza l'uso di utensili - con 5 lame incluse	4	566054
566.11	sistema automatico di ricarica della lama - regolazione della lama in 3 posizioni - con 5 lame incluse	2	566115



CUTTER PROFESSIONALE

Con lama retraibile a spezzare, regolabile e trancialama nel manico

566.12	lama 25 mm - con guida in metallo ed impugnatura in gomma	12	566122
566.14	lama 9 mm - con guida in metallo ed impugnatura in gomma - con 3 lame incluse	24	566146
566.16	lama 18 mm - con guida in metallo ed impugnatura in gomma - con 3 lame incluse	24	566160



CUTTER - In espositore self-service

Con meccanismo autobloccante della lama, vano portalama nel manico, sistema di ricarica automatica della lama

566.17	lama 9 mm - con guida in metallo e corpo in bimatrimiale - con 3 lame incluse	12	566177
566.18	lama 18 mm - con guida in metallo e corpo in bimatrimiale - con 3 lame incluse	12	566184



CUTTER

Con lama retraibile a spezzare, regolabile e trancialama nel manico

566.20	lama 9 mm - corpo in metallo	24	566207
566.23	lama 9 mm - corpo in ABS	24	566238
566.25	lama 9 mm - con guida in metallo	24	566252



CUTTER

Con lama retraibile a spezzare, regolabile e trancialama nel manico

**566.30** lama **9** mm - corpo in ABS trasparente 24 566306**566.40** lama **18** mm - corpo in ABS trasparente 24 566405**566.50** lama **18** mm - con guida in metallo 24 566504**566.60** lama **18** mm - con guida in metallo 24 566603**RASCHIETTO****567.00** raschietto con lama retraibile 24 567006**LAME DI RICAMBIO****568.00** **5** lame a trapezio piccole 12 568003**568.10** **5** lame a trapezio grandi 12 568102**568.20** **5** lame ad uncino 12 568201**568.30** **10** lame a spezzare **9** mm 12 568300**568.40** **10** lame a spezzare **18** mm 12 568409**568.50** **5** lame a spezzare **25** mm 12 568508**TAGLIAVETRO****569.00** con rotella in metallo duro 5 569000

SGORBIE con impugnatura in legno per falegname

570.00	5 sgorbie assortite	<input checked="" type="checkbox"/>	570006
572.00	6 sgorbie assortite	<input checked="" type="checkbox"/>	572000

**SCALPELLO** con impugnatura in legno per falegname

575.00	6 mm	<input type="checkbox"/>	575001
576.00	8 mm	<input type="checkbox"/>	576008
577.00	10 mm	<input type="checkbox"/>	577005
578.00	12 mm	<input type="checkbox"/>	578002
579.00	14 mm	<input type="checkbox"/>	579009
580.00	16 mm	<input type="checkbox"/>	580005
581.00	18 mm	<input type="checkbox"/>	581002
582.00	20 mm	<input type="checkbox"/>	582009
583.00	26 mm	<input type="checkbox"/>	583006
584.00	30 mm	<input type="checkbox"/>	584003
585.00	32 mm	<input type="checkbox"/>	585000
586.00	40 mm	<input type="checkbox"/>	586007

**TRIVELLINO** per legno

590.00	∅ 2 mm	<input checked="" type="checkbox"/>	590004
591.00	∅ 3 mm	<input checked="" type="checkbox"/>	591001
592.00	∅ 4 mm	<input checked="" type="checkbox"/>	592008
593.00	∅ 5 mm	<input checked="" type="checkbox"/>	593005
594.00	∅ 6 mm	<input checked="" type="checkbox"/>	594002
595.00	∅ 8 mm	<input checked="" type="checkbox"/>	595009
597.00	3 trivellini ∅ 2 - 3 - 4 mm	<input checked="" type="checkbox"/>	597003



LEVA CHIODI

598.00	190 mm	<input checked="" type="checkbox"/>	598000
---------------	---------------	-------------------------------------	--------

PIALLA E SPONDERUOLA IN LEGNO

Con lama in acciaio - piana per rifinitura



624.00	36 mm	<input checked="" type="checkbox"/>	624006
625.00	45 mm - doppia lama	<input checked="" type="checkbox"/>	625003
626.00	48 mm - doppia lama	<input checked="" type="checkbox"/>	626000
628.00	24 mm	<input checked="" type="checkbox"/>	628004
629.00	27 mm	<input checked="" type="checkbox"/>	629001

LAMA IN ACCIAIO

624.10	36 mm - per art. 624.00	<input checked="" type="checkbox"/>	624105
625.10	45 mm - per art. 625.00	<input checked="" type="checkbox"/>	625102
626.10	48 mm - per art. 626.00	<input checked="" type="checkbox"/>	626109
628.10	24 mm - per art. 628.00	<input checked="" type="checkbox"/>	628103
629.10	27 mm - per art. 629.00	<input checked="" type="checkbox"/>	629100

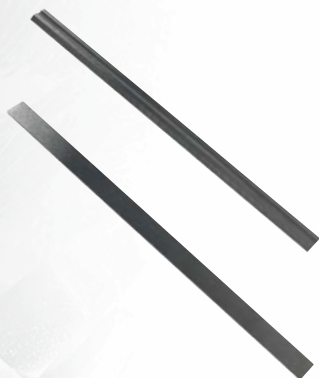
LAME REVERSIBILI IN METALLO DURO PER PIALLETTI ELETTRICI

codice	caratteristiche	utilizzabili su:	q.tà	EAN13 8011017
629.85	2 lame 75,5 x 5,5 x 1,1 mm	AEG - B&D - Bosch - Festo - Haffner - Holz Her - Kress - Mafell - Metabo - Scheer - Skil	<input checked="" type="checkbox"/>	629858
629.87	2 lame 80,5 x 5,9 x 1,1 mm	Elu - B&D	<input checked="" type="checkbox"/>	629872
629.89	2 lame 82,0 x 5,5 x 1,1 mm	AEG - B&D - Bosch - Fein - Felisatti - Festo - Haffner - Hitachi - Holz Her - Mafell - Makita - Metabo - Skil	<input checked="" type="checkbox"/>	629896
629.93	2 lame 102,0 x 5,5 x 1,1 mm	AEG	<input checked="" type="checkbox"/>	629933

GRAFFATRICE

601.00	modello hobby per punti 4 - 6 - 8 mm	1	601007
604.00	con corpo in metallo e regolatore di pressione per punti da 4 a 14 mm	1	604008



PUNTI PER GRAFFATRICE

607.30	5000 punti 6 mm	5	607306
607.35	1000 punti 6 mm	10	607351
607.40	5000 punti 8 mm	5	607405
607.45	1000 punti 8 mm	10	607450
607.50	5000 punti 10 mm	5	607504
607.55	1000 punti 10 mm	10	607559
607.60	5000 punti 12 mm	5	607603
607.65	1000 punti 12 mm	10	607658
607.70	5000 punti 14 mm	5	607702
607.75	1000 punti 14 mm	10	607757

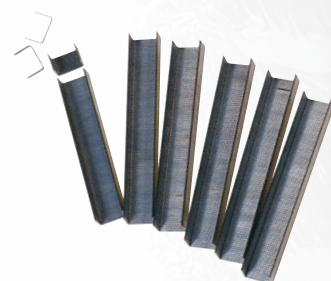

FLESSOMETRO

Nastro in metallo plastificato, corpo in ABS anti-urto, rientro automatico e clip per cintura, con doppio dispositivo di bloccaggio



611.10	3 m - nastro 16 mm - €€	<input type="checkbox"/>	12	611105
611.20	5 m - nastro 19 mm - €€	<input type="checkbox"/>	6	611204
611.30	8 m - nastro 25 mm - €€	<input type="checkbox"/>	4	611303



ESPOSITORE FLESSOMETRI

611.65	24 flessometri 5 m art. 611.20 - €€	<input type="checkbox"/>	1	611655
---------------	--	--------------------------	---	--------

MATITA DA FALEGNAME

649.00	180 mm	144	009407
649.06	6 matite 180 mm	5	649061



MORSETTO PER SPINATURA

650.00	completo di tasselli in legno \varnothing 6 - 8 - 10 mm e 3 spaziatori	1	650005
--------	--	---	--------



TASSELLI DI LEGNO

655.00	100 tasselli \varnothing 6 x 30 mm	10	655000
655.05	1000 tasselli \varnothing 6 x 30 mm	1	655055
660.00	60 tasselli \varnothing 8 x 35 mm	10	660004
660.05	1000 tasselli \varnothing 8 x 35 mm	1	660059
665.00	40 tasselli \varnothing 10 x 40 mm	10	665009
665.05	1000 tasselli \varnothing 10 x 40 mm	1	665054
666.00	30 tasselli \varnothing 12 x 40 mm	10	666006
666.05	500 tasselli \varnothing 12 x 40 mm	1	666051



TASSELLI DI LEGNO IN ASTE

668.00	100 aste \varnothing 6 x 1000 mm	1	668000
668.10	100 aste \varnothing 8 x 1000 mm	1	668109
668.20	100 aste \varnothing 10 x 1000 mm	1	668208
668.30	50 aste \varnothing 12 x 1000 mm	1	668307
668.40	40 aste \varnothing 14 x 1000 mm	1	668406
668.50	40 aste \varnothing 16 x 1000 mm	1	668505



LAMELLE DI LEGNO

669.00	50 lamelle tipo 0 - 48 x 16 x 4 mm	<input checked="" type="checkbox"/>	669007
669.05	1000 lamelle tipo 0 - 48 x 16 x 4 mm	<input type="checkbox"/>	669052
669.10	50 lamelle tipo 10 - 53 x 19 x 4 mm	<input checked="" type="checkbox"/>	669106
669.15	1000 lamelle tipo 10 - 53 x 19 x 4 mm	<input type="checkbox"/>	669151
669.20	50 lamelle tipo 20 - 61 x 24 x 4 mm	<input checked="" type="checkbox"/>	669205
669.25	1000 lamelle tipo 20 - 61 x 24 x 4 mm	<input type="checkbox"/>	669250

BOCCOLE DI ARRESTO

620.00	3 boccole \varnothing 6 - 8 - 10 mm	<input checked="" type="checkbox"/>	620008
620.10	1 boccola \varnothing 12 mm	<input checked="" type="checkbox"/>	620107
620.20	1 boccola \varnothing 14 mm	<input checked="" type="checkbox"/>	620206

SPINE A CENTRARE

670.00	4 spine \varnothing 6 mm	<input checked="" type="checkbox"/>	670003
675.00	4 spine \varnothing 8 mm	<input checked="" type="checkbox"/>	675008
680.00	4 spine \varnothing 10 mm	<input checked="" type="checkbox"/>	680002
680.10	4 spine \varnothing 12 mm	<input checked="" type="checkbox"/>	680101
680.20	2 spine \varnothing 14 mm	<input checked="" type="checkbox"/>	680200

KIT DI ASSEMBLAGGIO

681.00	con punta per trapano \varnothing 6 mm - boccola di arresto 4 spine a centrare - 25 tasselli di legno	<input checked="" type="checkbox"/>	681009
682.00	con punta per trapano \varnothing 8 mm - boccola di arresto 4 spine a centrare - 25 tasselli di legno	<input checked="" type="checkbox"/>	682006
683.00	con punta per trapano \varnothing 10 mm - boccola di arresto 4 spine a centrare - 20 tasselli di legno	<input checked="" type="checkbox"/>	683003

codice

caratteristiche

q.tà
imballoEAN13
8011017**LAME PER
SEGHETTI
ALTERNATIVI****LAME PER SEGHETTI ALTERNATIVI - ATTACCO BLACK & DECKER****HSS - per metallo**

684.00	3 lame - denti grossi	10	684000
685.00	3 lame - denti medi	10	685007
686.00	3 lame - denti fini	10	686004
686.50	3 lame - denti medi - lunghezza 80 mm	10	686509

**CV - per laminati e legno**

687.00	3 lame - denti grossi	10	687001
688.00	3 lame - denti medi	10	688008
689.00	3 lame - denti fini	10	689005
689.10	3 lame - denti grossi - con lama rettificata	10	689104
689.20	3 lame - denti medi - con lama rettificata	10	689203
689.50	3 lame - denti medi - lunghezza 100 mm	10	689500
720.00	3 lame - denti medi - per tagli sagomati	10	720005
720.50	2 lame - a doppia dentatura - lunghezza 115 mm - per tagli curvi estremi privi di sbavature	5	720500

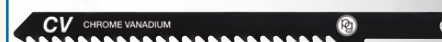
**METALLO DURO - per vetro, ceramica e laterizi**

724.00	1 lama	5	724003
---------------	---------------	---	--------

**KIT 10 LAME PER SEGHETTI ALTERNATIVI - ATTACCO BLACK & DECKER**

720.90	3 lame CV denti grossi per legno + 3 lame CV denti medi per legno + 2 lame CV tagli curvi per legno + 2 lame HSS denti fini per metallo	3	720906
---------------	---	---	--------

 imballo PG

 imballo neutro

**LAME PER SEGHETTI ALTERNATIVI - ATTACCO BOSCH LARGO
HSS - per metallo**

694.00	3 lame - denti grossi	10	694009
695.00	3 lame - denti medi	10	695006
696.00	3 lame - denti fini	10	696003
696.50	3 lame - denti medi - lunghezza 80 mm	10	696508

CV - per laminati e legno

697.00	3 lame - denti grossi	10	697000
698.00	3 lame - denti medi	10	698007
699.00	3 lame - denti fini	10	699004
699.10	3 lame - denti grossi - con lama rettificata	10	699103
699.20	3 lame - denti medi - con lama rettificata	10	699202
699.50	3 lame - denti medi - lunghezza 100 mm	10	699509
699.60	2 lame - denti medi - lunghezza 220 mm - per materiali isolanti e styropor	10	087399
721.00	3 lame - denti medi - per tagli sagomati	5	721002
721.50	2 lame - a doppia dentatura - lunghezza 115 mm - per tagli curvi estremi privi di sbavature	10	721507

METALLO DURO - per vetro, ceramica e laterizi

725.00	1 lama	5	725000
---------------	---------------	----------	--------

KIT 10 LAME PER SEGHETTI ALTERNATIVI - ATTACCO BOSCH LARGO

721.90	3 lame CV denti grossi per legno + 3 lame CV denti medi per legno + 2 lame CV tagli curvi per legno + 2 lame HSS denti fini per metallo	3	721903
---------------	---	----------	--------

LAME PER SEGHETTI ALTERNATIVI - ATTACCO MAKITA**HSS** - per metallo

714.00	3 lame - denti grossi	10	714004
715.00	3 lame - denti medi	10	715001
716.00	3 lame - denti fini	10	716008

HSS HIGH SPEED STEEL**CV** - per laminati e legno

717.00	3 lame - denti grossi	10	717005
718.00	3 lame - denti medi	10	718002
719.00	3 lame - denti fini	10	719009
722.00	3 lame - denti medi - per tagli sagomati	10	722009

CV CHROME VANADIUM**CV** CHROME VANADIUM**LAME PER SEGHETTI ALTERNATIVI - ATTACCO BOSCH STRETTO****HSS** - per metallo

704.00	3 lame - denti grossi	10	704005
705.00	3 lame - denti medi	10	705002
706.00	3 lame - denti fini	10	706009

HSS HIGH SPEED STEEL**CV** - per laminati e legno

707.00	3 lame - denti grossi	10	707006
708.00	3 lame - denti medi	10	708003

CV CHROME VANADIUM

SEGA A TAZZA

Per legno, cartongesso e materie sintetiche



730.00	con 7 lame da \varnothing 25 mm a \varnothing 62 mm altezza 25 mm	<input type="checkbox"/>	10	730004
732.00	con 7 lame da \varnothing 25 mm a \varnothing 62 mm altezza 50 mm	<input type="checkbox"/>	10	732008
735.00	con 5 lame da \varnothing 60 mm a \varnothing 95 mm altezza 40 mm	<input type="checkbox"/>	5	735009

TAGLIAPIASTRELLE CIRCOLARE

Con punta centrante e tagliente in metallo duro

217.00	per forare da \varnothing 30 mm a \varnothing 100 mm - 450 RPM	<input type="checkbox"/>	1	217000
217.10	utensile di ricambio per art. 217.00	<input type="checkbox"/>	1	217109

ALBERO PER SEGA A TAZZA BIMETAL

13.780	\varnothing 14/30 mm - gambo \varnothing 6,35 mm	<input type="checkbox"/>	1	137803
13.785	\varnothing 32/152 mm - gambo \varnothing 6,35 mm	<input type="checkbox"/>	1	137858
13.790	\varnothing 14/30 mm - gambo ch. 12 mm	<input type="checkbox"/>	1	137902
13.795	\varnothing 32/152 mm - gambo ch. 12 mm	<input type="checkbox"/>	1	137957

PUNTA DI RICAMBIO PER ALBERO BIMETAL

13.800	lunghezza 115 mm	<input type="checkbox"/>	1	138008
13.805	lunghezza 70 mm	<input type="checkbox"/>	1	138053

SEGA A TAZZA BIMETAL

13.500	ø 14 mm	1	135007
13.505	ø 16 mm	1	135052
13.510	ø 17 mm	1	135106
13.515	ø 19 mm	1	135151
13.520	ø 20 mm	1	135205
13.525	ø 21 mm	1	135250
13.530	ø 22 mm	1	135304
13.535	ø 24 mm	1	135359
13.540	ø 25 mm	1	135403
13.545	ø 27 mm	1	135458
13.550	ø 29 mm	1	135502
13.555	ø 30 mm	1	135557
13.560	ø 32 mm	1	135601
13.565	ø 33 mm	1	135656
13.570	ø 35 mm	1	135700
13.575	ø 37 mm	1	135755
13.580	ø 38 mm	1	135809
13.585	ø 40 mm	1	135854
13.590	ø 41 mm	1	135908
13.595	ø 43 mm	1	135953
13.600	ø 44 mm	1	136004
13.605	ø 46 mm	1	136059
13.610	ø 48 mm	1	136103
13.615	ø 51 mm	1	136158
13.620	ø 52 mm	1	136202
13.625	ø 54 mm	1	136257
13.630	ø 57 mm	1	136301
13.635	ø 59 mm	1	136356
13.640	ø 60 mm	1	136400
13.645	ø 64 mm	1	136455
13.650	ø 65 mm	1	136509
13.655	ø 67 mm	1	136554
13.660	ø 70 mm	1	136608
13.665	ø 73 mm	1	136653
13.670	ø 76 mm	1	136707
13.675	ø 79 mm	1	136752
13.680	ø 83 mm	1	136806
13.685	ø 86 mm	1	136851
13.690	ø 89 mm	1	136905
13.695	ø 92 mm	1	136950
13.700	ø 95 mm	1	137001
13.705	ø 98 mm	1	137056
13.710	ø 102 mm	1	137100
13.715	ø 105 mm	1	137155
13.720	ø 108 mm	1	137209
13.725	ø 111 mm	1	137254
13.730	ø 114 mm	1	137308
13.735	ø 121 mm	1	137353
13.740	ø 127 mm	1	137407
13.745	ø 140 mm	1	137452
13.750	ø 152 mm	1	137506



imballo PG



imballo neutro

SEGA CIRCOLARE IN CV

ø mm		nr. denti	RPM	codice	q.tà	EAN13 8011017
est.	foro					
125	20	24	7000	740.00	(5)	740003
125	20	80	7000	745.00	(5)	745008
150	20	24	7000	750.00	(5)	750002
150	20	80	7000	755.00	(5)	755007

 Sono incluse **2** riduzioni per fori: **20/13** mm e **20/16** mm

**SEGA CIRCOLARE CON RIPORTO IN METALLO DURO
DENTATURA ALTERNATA**

ø mm		nr. denti	utilizzabili su:	RPM	codice	q.tà	EAN13 8011017
est.	foro						
125	20	18	Bosch - Festo - Haffner - Hitachi - Mafell - Metabo - Ulmia	13000	756.02	(1)	756028
140	20	18	AEG - Bosch - Peugeot - Holz Her - Makita - Metabo - Stayer	13000	756.06	(1)	756066
150	20	20	AEG - B&D - Bosch - Elu - Fein - Hitachi - Kress - Mafell - Metabo - Peugeot - Scheer - Skil - Wegoma	13000	756.10	(1)	756103
150	30	36		13000	756.12	(1)	756127
160	20	24	AEG - B&D - Bosch - Einhell - Fein - Festo - Haffner - Hitachi - Holz Her - Kress - Mafell - Makita - Narex - Peugeot - Protool - Rockwell - Ryobi - Scheer - Skil - Ulmia	9500	756.14	(1)	756141
160	20	36		9500	756.16	(1)	756165
170	30	18	Bosch - Elu - Festo - Haffner - Hitachi - Holz Her - Mafell - Makita - Metabo - Skil	9500	756.18	(1)	756189
170	30	36		9500	756.20	(1)	756202
180	30	22	B&D - Bosch - Elu - Festo - Haffner - Hitachi - Holz Her - Mafell - Makita - Metabo - Peugeot - Ryobi - Skil	9500	756.22	(1)	756226
180	30	36		9500	756.24	(1)	756240
180	30	52		9500	756.26	(1)	756264
190	30	30	AEG - B&D - Bosch - DeWalt - Elu - Festo - Hitachi - Holz Her - Kress - Mafell - Makita - Metabo - Protool - Scheer - Skil - Stayer	9500	756.28	(1)	756288
190	30	42		9500	756.30	(1)	756301
200	30	42	AEG - B&D - Bosch - Festo - Haffner - Hanning - Holz Her - Kity - Mafell - Makita - Ryobi - Scheer - Ulmia	9500	756.32	(1)	756325
200	30	60		9500	756.34	(1)	756349
210	30	20	AEG - B&D - Bosch - Elektra Beckum - Elu - Fein - Haffner - Hitachi - Holz Her - Mafell - Makita - Metabo - Skil - Stayer	9500	756.36	(1)	756363
210	30	30		9500	756.38	(1)	756387
210	30	42		9500	756.40	(1)	756400
230	30	20	AEG - B&D - Bosch - Festo - Haffner - Holz Her - Mafell - Peugeot - Scheer - Skil - Stayer	9500	756.42	(1)	756424
230	30	34		9500	756.44	(1)	756448
230	30	40		9500	756.46	(1)	756462
250	30	24	Elektra Beckum - Elu - Mafell - Metabo	8000	756.48	(1)	756486
250	30	48		8000	756.50	(1)	756509
250	30	60		8000	756.52	(1)	756523
300	30	48	Elektra Beckum - Elu	4000	756.54	(1)	756547
300	30	72		4000	756.56	(1)	756561
300	30	96		4000	756.58	(1)	756585
350	30	84	Festo	4000	756.60	(1)	756608
350	30	108		4000	756.62	(1)	756622

MANDRINO AUTOSERRANTE

Attacco maschio

760.00	3/8 x 24 - serraggio fino \varnothing 10 mm per Black & Decker	1	760001
---------------	---	---	--------

**MANDRINO AUTOSERRANTE**

Attacco femmina

762.00	3/8 x 24 - serraggio fino \varnothing 10 mm per Skil, Metabo, Makita, Wolf	1	762005
764.00	3/8 x 24 - serraggio fino \varnothing 13 mm per Skil, Metabo, Makita, Wolf	1	764009
766.00	1/2 x 20 - serraggio fino \varnothing 10 mm per Atlas Copco, Bosch, Fein, Kress, Metabo	1	766003
768.00	1/2 x 20 - serraggio fino \varnothing 13 mm per Atlas Copco, Bosch, Fein, Kress, Metabo	1	768007

**MANDRINO SENZA CHIAVE** per utensili reversibili

Attacco maschio

773.00	3/8 x 24 - serraggio fino \varnothing 10 mm per Black & Decker	1	773001
---------------	---	---	--------

**MANDRINO SENZA CHIAVE** per utensili reversibili

Attacco femmina

774.00	3/8 x 24 - serraggio fino \varnothing 10 mm per Skil, Metabo, Makita, Wolf	1	774008
774.50	3/8 x 24 - serraggio fino \varnothing 13 mm per Skil, Metabo, Makita, Wolf	1	774503
775.00	1/2 x 20 - serraggio fino \varnothing 10 mm per Atlas Copco, Bosch, Fein, Kress, Metabo	1	775005
775.50	1/2 x 20 - serraggio fino \varnothing 13 mm - corpo in metallo - UTILIZZABILE ANCHE SU TRAPANI A PERCUSSIONE per Atlas Copco, Bosch, Fein, Kress, Metabo	1	775500
775.60	1/2 x 20 - serraggio fino \varnothing 13 mm per Atlas Copco, Bosch, Fein, Kress, Metabo	1	775609

**MANDRINO SENZA CHIAVE**

Attacco SDS

775.51	serraggio fino \varnothing 13 mm - corpo in metallo - UTILIZZABILE ANCHE SU TRAPANI A PERCUSSIONE	1	775517
775.61	serraggio fino \varnothing 13 mm	1	775616



MANDRINO A CREMAGLIERA

Attacco maschio



780.00	3/8 x 24 - serraggio fino \varnothing 10 mm per Black & Decker	1	780009
781.00	3/8 x 24 - serraggio fino \varnothing 13 mm per Black & Decker	1	781006

MANDRINO A CREMAGLIERA

Attacco femmina



783.00	3/8 x 24 - serraggio fino \varnothing 10 mm per Skil, Metabo, Makita, Wolf (38 mm)	1	783000
784.00	3/8 x 24 - serraggio fino \varnothing 13 mm per Skil, Metabo, Makita, Wolf (38 mm)	1	784007
786.00	1/2 x 20 - serraggio fino \varnothing 10 mm per Atlas Copco, Bosch, Fein, Kress, Metabo (43 mm)	1	786001
787.00	1/2 x 20 - serraggio fino \varnothing 13 mm per Atlas Copco, Bosch, Fein, Kress, Metabo (43 mm)	1	787008

MANDRINO A CREMAGLIERA

Attacco SDS



787.01	serraggio fino \varnothing 13 mm	1	787015
---------------	---	---	--------

MANDRINO A CREMAGLIERA

Attacco esagonale



788.00	serraggio fino \varnothing 10 mm	1	788005
---------------	---	---	--------

MANDRINO PER SVITA-AVVITA

Attacco esagonale



788.50	serraggio \varnothing 0,5-6,5 mm	5	788500
---------------	---	---	--------

RACCORDO PER MANDRINO

789.00	attacco SDS plus 1/2 x 20	5	789002
789.10	vite M6 sinistra per mandrini	1	789101
789.50	maschio 3/8 - maschio 1/2	1	789507
789.60	maschio 3/8 - maschio 3/8	1	789606
789.70	maschio 1/2 - femmina 3/8	1	789705



CHIAVE PER MANDRINO

790.00	10 mm - per Black & Decker	10	790008
791.00	13 mm - per Black & Decker	10	791005
792.00	13 mm - universale	10	792002
793.00	16 mm - universale	5	793009
794.00	universale	5	794006



ALBERO FLESSIBILE

550.00	lunghezza 90 cm con mandrino \varnothing 6 mm 4000 RPM - C€	1	550008
555.00	lunghezza 130 cm con mandrino \varnothing 8 mm professionale - 4000 RPM - C€	1	555003
560.00	lunghezza 130 cm con mandrino \varnothing 8 mm con cuscinetti a sfera - professionale - 8000 RPM - C€	1	560007



MANDRINO PER ALBERO FLESSIBILE

550.06	\varnothing 6 mm	1	550060
555.08	\varnothing 8 mm	1	555089



PENNA CON PUNTA IN METALLO DURO

598.50	penna per tracciare su metallo, vetro e piastrelle	5	598505
---------------	--	---	--------

PISTOLA TERMOCOLLANTE

Ugello con protezione termica, dispositivo antigoccia. Ad avanzamento automatico. Corpo in plastica antiurto. Per incollare carta, plastica, legno, ceramica, tessuti



599.00	20 W - con 2 stick di colla ø 7 mm	1	599007
---------------	------------------------------------	---	--------

599.20	40 W - con 2 stick di colla ø 11 mm	1	599205
---------------	-------------------------------------	---	--------

STICK COLLA A CALDO

600.00	12 stick ø 7 mm - lunghezza 100 mm	10	600000
---------------	------------------------------------	----	--------

600.20	12 stick ø 11 mm - lunghezza 100 mm	10	600208
---------------	-------------------------------------	----	--------

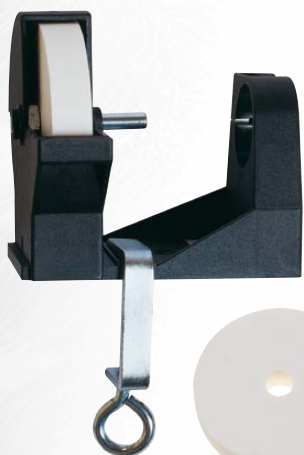
MOLA AD ACQUA

880.00	ø 100 x 20 x 16 mm per trapani con collare ø 43 mm - C€	1	880006
---------------	--	---	--------

882.00	mola di ricambio ø 100 x 20 mm - foro ø 16 mm per art. 880.00	1	882000
---------------	--	---	--------

POMPA PER LIQUIDI

890.00	gambo ø 8 mm - per tubi 1/2" - 2500 l/h 3000 RPM - C€	5	890005
---------------	--	---	--------

TRAPANO A MANO

921.00	con mandrino autoserrante ø 6 mm manico in plastica - porta punta	5	921006
924.00	con mandrino autoserrante ø 8 mm manico in plastica - porta punta	1	924007
928.00	con mandrino autoserrante ø 13 mm a due velocità - con appoggio	1	928005





MANDRINO DI RICAMBIO PER TRAPANO A MANO

930.00	ø 6 mm	1	930008
932.00	ø 8 mm	1	932002
936.00	ø 13 mm	1	936000



SET CHIAVI IN CV

946.00	8 chiavi a brugola per viti esagonali 1,5 - 2 - 2,5 - 3 - 4 - 5 - 5,5 - 6		10	946009
946.50	10 chiavi a brugola per viti esagonali 1,5 - 2 - 2,5 - 3 - 4 - 5 - 5,5 - 6 - 8 - 10		10	946504
947.00	8 chiavi per viti Torx T9 - T10 - T15 - T20 - T25 - T27 - T30 - T40		10	947006



STRETTOIO PER FALEGNAME in acciaio

948.00	apertura 150 mm	6	948003
948.10	apertura 200 mm	6	948102
948.20	apertura 250 mm	6	948201
948.30	apertura 300 mm	6	948300
948.40	apertura 400 mm	4	948409
948.50	apertura 500 mm	4	948508
948.60	apertura 600 mm	4	948607
948.65	apertura 700 mm	2	948652
948.70	apertura 800 mm	2	948706
948.80	apertura 1000 mm	2	948805
948.82	apertura 1200 mm	2	948829
948.84	apertura 1500 mm	2	948843
948.86	apertura 2000 mm	2	948867
948.88	apertura 2500 mm	2	948881
948.90	apertura 3000 mm	2	948904

STRETTOIO AUTOBLOCCANTE

948.93	apertura 150 mm	4	948935
948.95	apertura 300 mm	4	948959
948.97	apertura 450 mm	4	948973

MORSETTO DI SERRAGGIO A "C" AUTOBLOCCANTE

Con tasto di regolazione rapida

949.00	80 x 65 mm	1	949000
949.10	105 x 75 mm	1	949109
949.20	160 x 75 mm	1	949208

MORSETTO A REGOLAZIONE RAPIDA

949.50	apertura 50 mm	5	949505
949.60	apertura 75 mm	5	949604
949.70	apertura 100 mm	5	949703

**MORSETTO**

951.00	apertura 25 mm	10	951003
952.00	apertura 50 mm	10	952000
953.00	apertura 75 mm	10	953007



MORSA DA BANCO con regolazione rapida e ganasce con scanalature per il serraggio di pezzi rotondi

954.00	apertura 70 mm	1	954004
---------------	-----------------------	---	--------

**MORSETTO PER SERRAGGIO AD ANGOLO 90°**

955.00	con regolazione rapida, per l'allineamento ed il bloccaggio di parti da incollare, saldare, avvitare o inchiodare	1	955001
---------------	---	---	--------

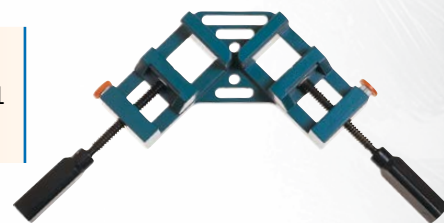
**MORSETTO AD ANGOLO** per cornici

956.00	apertura 75 mm	5	956008
---------------	-----------------------	---	--------



MORSETTO PER SERRAGGIO A NASTRO

Per serrare durante l'incollatura di cornici, scaffalature e mobili



957.00	lunghezza 4 m	1	957005
---------------	----------------------	----------	--------

MORSETTO A CRICCO

957.50	apertura 50 mm	5	957500
---------------	-----------------------	----------	--------

MORSETTO A CRICCO

957.70	apertura 70 mm	5	957708
---------------	-----------------------	----------	--------

MINI MORSETTI A MOLLA

958.00	kit 4 mini morsetti - apertura 18 mm	10	958002
---------------	--	-----------	--------

MORSETTI A MOLLA

958.05	apertura 30 mm	10	958057
---------------	-----------------------	-----------	--------

958.07	apertura 40 mm	10	958071
---------------	-----------------------	-----------	--------

958.10	apertura 60 mm	10	958101
---------------	-----------------------	-----------	--------

958.14	apertura 70 mm	10	958149
---------------	-----------------------	-----------	--------

SUPPORTO ORIENTABILE per trapano

960.00	per trapani con collare ø 43 mm	1	960005
---------------	--	---	--------

**TORNIO DA BANCO** per lavorare il legno

965.00	distanza regolabile per trapani con collare ø 43 mm	1	965000
---------------	---	---	--------

**SUPPORTO** per fresare

970.00	per trapani con collare ø 43 mm	1	970004
---------------	--	---	--------

**GUIDA REGOLABILE** per trapano

972.00	per forare e fresare in ogni angolazione 0-45° per trapani con collare ø 43 mm	1	972008
---------------	---	---	--------

**SUPPORTO UNIVERSALE** per smerigliatrice angolare

Per il taglio preciso di profili e tubi in metallo. Base di lavoro con dispositivo di serraggio rapido regolabile

50.060	disco ø 150/230 mm - apertura morsa 113 mm - base in ghisa 335 x 292 mm - modello professionale	1	500607
50.070	disco ø 150/230 mm - apertura morsa 102 mm - base in lamiera 332 x 293 mm - modello professionale	1	500706
50.080	disco ø 150/230 mm - apertura morsa 100 mm - base in lamiera 290 x 295 mm - modello hobby	1	500805
50.090	disco ø 115/125 mm - apertura morsa 77 mm - base in zama 240x190 mm - modello hobby	1	500904



SUPPORTO UNIVERSALE per trapano

Per forare con precisione ed in sicurezza. Piano di lavoro con sistema di ancoraggio per il fissaggio di staffe di bloccaggio o morse

50.010	con collare girevole \varnothing 43 mm - altezza 440 mm - corsa 65 mm - luce (distanza albero/centro mandrino) 99,5 mm - altezza lavoro 260 mm - asta \varnothing 22 mm - molla di richiamo integrata - base in alluminio 250 x 180 mm - modello professionale	1	500102
50.020	con collare girevole \varnothing 43 mm - altezza 420 mm - corsa 60 mm - luce (distanza albero/centro mandrino) 96 mm - altezza lavoro 240 mm - asta \varnothing 22 mm - molla di richiamo integrata - base in alluminio 220 x 175 mm - modello hobby	1	500201
50.030	con collare girevole \varnothing 60 mm - dotato di 3 collari di riduzione \varnothing 43-50-53 mm - altezza 500 mm - corsa 65 mm - luce (distanza albero/centro mandrino) 95 mm - altezza lavoro 320 mm - asta \varnothing 30 mm - molla di richiamo integrata - base in alluminio 250 x 180 mm - modello professionale	1	500300
50.040	con collare girevole \varnothing 60 mm - dotato di 3 collari di riduzione \varnothing 43-50-53 mm - altezza 500 mm - corsa 65 mm - luce (distanza albero/centro mandrino) 95 mm - altezza lavoro 320 mm - asta \varnothing 30 mm - molla di richiamo integrata - base in ghisa 250 x 180 mm - modello professionale	1	500409

COLLARE DI RIDUZIONE per supporto

43.034	\varnothing 43 x 34 mm	1	430348
43.037	\varnothing 43 x 37 mm	1	430379
43.038	\varnothing 43 x 38 mm	1	430386
43.384	\varnothing 43 x 38,4 mm	1	433844
60.043	\varnothing 60 x 43 mm	1	600437
60.046	\varnothing 60 x 46 mm	1	600468
60.050	\varnothing 60 x 50 mm	1	600505
60.053	\varnothing 60 x 53 mm	1	600536
60.054	\varnothing 60 x 54 mm	1	600543
60.056	\varnothing 60 x 56 mm	1	600567

RACCOGLI - POLVERE

565.00	per punte da \varnothing 4 mm a \varnothing 10 mm	10	565002
---------------	---	----	--------

PUNTA IN METALLO DURO per vetro e ceramica

728.00	\varnothing 3 mm	5	728001
728.10	\varnothing 4 mm	5	728100
728.20	\varnothing 5 mm	5	728209
728.30	\varnothing 6 mm	5	728308
728.40	\varnothing 8 mm	5	728407
728.50	\varnothing 10 mm	5	728506
728.60	\varnothing 12 mm	5	728605

KIT DI PUNTE ASSORTITE

15.606	5 punte per LEGNO \varnothing 4 - 5 - 6 - 8 - 10 mm	2	156064
15.607	8 punte per LEGNO \varnothing 3 - 4 - 5 - 6 - 7 - 8 - 9 - 10 mm	2	156071
15.608	5 punte per MURO \varnothing 4 - 5 - 6 - 8 - 10 mm	2	156088
15.610	8 punte per MURO \varnothing 3 - 4 - 5 - 6 - 7 - 8 - 9 - 10 mm	2	156101
15.615	13 punte per METALLO \varnothing 1,5 - 2 - 2,5 - 3 - 3,3 - 3,5 - 4 - 4,2 - 4,5 - 5 - 5,5 - 6 - 6,5 mm	2	156156
15.620	13 punte per METALLO \varnothing 2 - 2,5 - 3 - 3,5 - 4 - 4,5 - 5 - 5,5 - 6 - 6,5 - 7 - 7,5 - 8 mm	2	156200
15.630	9 punte per METALLO \varnothing 3 - 4 - 5 - 6 - 8 mm per MURO \varnothing 4 - 5 - 6 - 8 mm	2	156309
15.640	9 punte per METALLO, MURO, LEGNO \varnothing 5 - 6 - 8 mm	2	156408





PUNTA ELICOIDALE CILINDRICA IN ACCIAIO HSS per metallo - DIN 338
Attacco ch. 1/4

465.02	∅ 2 mm	10	465029
465.03	∅ 3 mm	10	465036
465.04	∅ 4 mm	10	465043
465.05	∅ 5 mm	10	465050



PUNTA ELICOIDALE CILINDRICA IN ACCIAIO HSS per metallo - DIN 338

∅ mm	BLISTER PG		SFUSO		q.tà
	codice	EAN13 8011017	codice	EAN13 8011017	
1	10.010 - 2 punte	100104	17.010	170107	10
1,5	10.015 - 2 punte	100159	17.015	170152	10
2	10.020 - 2 punte	100203	17.020	170206	10
2,5	10.025 - 2 punte	100258	17.025	170251	10
3	10.030 - 2 punte	100302	17.030	170305	10
3,5	10.035 - 2 punte	100357	17.035	170350	10
4	10.040 - 2 punte	100401	17.040	170404	10
4,5	10.045	100456	17.045	170459	10
5	10.050	100500	17.050	170503	10
5,5	10.055	100555	17.055	170558	10
6	10.060	100609	17.060	170602	10
6,5	10.065	100654	17.065	170657	10
7	10.070	100708	17.070	170701	10
7,5	10.075	100753	17.075	170756	10
8	10.080	100807	17.080	170800	10
8,5	10.085	100852	17.085	170855	10
9	10.090	100906	17.090	170909	10
9,5	10.095	100951	17.095	170954	10
10	10.100	101002	17.100	171005	10
10,5	10.105	101057	17.105	171050	10
11	10.110	101101	17.110	171104	10
11,5	10.115	101156	17.115	171159	10
12	10.120	101200	17.120	171203	10
12,5	10.125	101255	17.125	171258	10
13	10.130	101309	17.130	171302	10
13,5			17.135	171357	5
14			17.140	171401	5
14,5			17.145	171456	5
15			17.150	171500	5
15,5			17.155	171555	5
16			17.160	171609	5



PUNTA ELICOIDALE FRESATA - DIN 8039 - utilizzo a rotoperussione
Per mattoni, pietra, marmo, granito e cemento

ø mm	BLISTER PG		SFUSO		q.tà
	codice	EAN13 8011017	codice	EAN13 8011017	
3	15.030	150307	16.030	160306	10
4	15.040	150406	16.040	160405	10
5	15.050	150505	16.050	160504	10
5,5			16.055	160559	10
6	15.060	150604	16.060	160603	10
6,5			16.065	160658	10
7	15.070	150703	16.070	160702	10
8	15.080	150802	16.080	160801	10
9	15.090	150901	16.090	160900	10
10	15.100	151007	16.100	161006	10
11			16.110	161105	10
12	15.120	151205	16.120	161204	10
13			16.130	161303	10
14	15.140	151403	16.140	161402	10
15			16.150	161501	10
16			16.160	161600	10
18			16.180	161808	10
20			16.200	162003	10



PUNTA ELICOIDALE FRESATA - DIN 8039 - lunghezza **400** mm

ø mm	codice	EAN13 8011017	q.tà
8	16.408	164083	1
10	16.410	164106	1
12	16.412	164120	1
14	16.414	164144	1
16	16.416	164168	1
18	16.418	164182	1
20	16.420	164205	1
22	16.422	164229	1
25	16.425	164250	1



PUNTA ELICOIDALE FRESATA - DIN 8039 - lunghezza **600** mm

ø mm	codice	EAN13 8011017	q.tà
10	16.610	166100	1
12	16.612	166124	1
14	16.614	166148	1
16	16.616	166162	1
18	16.618	166186	1
20	16.620	166209	1

PUNTA IN CV per legno - DIN 7487



ø mm	BLISTER PG		SFUSO		q.tà
	codice	EAN13 8011017	codice	EAN13 8011017	
3	630.03	630038	14.003	140032	10
4	630.04	630045	14.004	140049	10
5	630.05	630052	14.005	140056	10
6	630.06	630069	14.006	140063	10
7	630.07	630076	14.007	140070	10
8	630.08	630083	14.008	140087	10
9	630.09	630090	14.009	140094	10
10	630.10	630106	14.010	140100	10
11	630.11	630113	14.011	140117	10
12	630.12	630120	14.012	140124	10
13	630.13	630137	14.013	140131	10
14	630.14	630144	14.014	140148	10
15			14.015	140155	10
16			14.016	140162	10
18			14.018	140186	5
20			14.020	140209	5
22			14.022	140223	5
24			14.024	140247	5
26			14.026	140261	2
28			14.028	140285	2
30			14.030	140308	2

PUNTA IN CV per legno - lunghezza 250 mm



ø mm	codice	EAN13 8011017	q.tà
6	14.206	142067	10
7	14.207	142074	10
8	14.208	142081	10
9	14.209	142098	10
10	14.210	142104	10
11	14.211	142111	10
12	14.212	142128	10
13	14.213	142135	5
14	14.214	142142	5
15	14.215	142159	5
16	14.216	142166	5
18	14.218	142180	2
20	14.220	142203	2
22	14.222	142227	2
24	14.224	142241	2

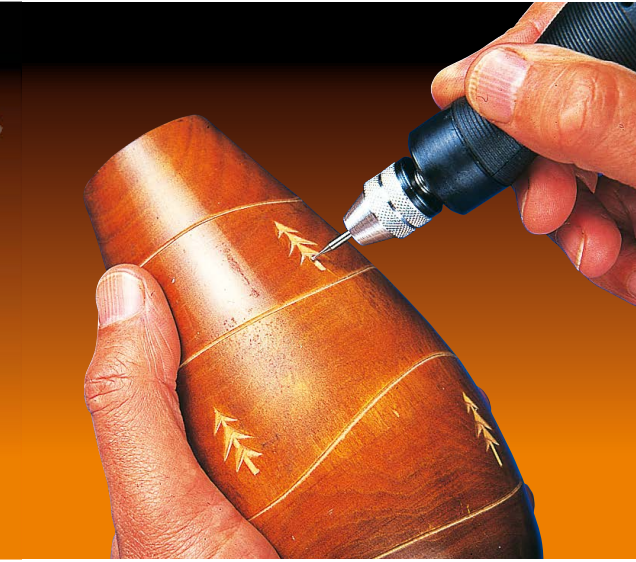
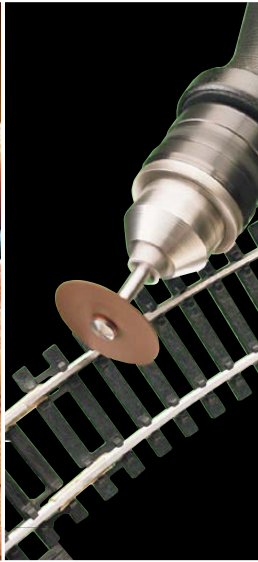



FRESE IN ACCIAIO

Per l'intaglio, l'incisione e la svasatura di legno, fibra di vetro, metalli teneri e plastica

M.1010	2 frese ø 1,4 mm - sfera - gambo ø 2,35 mm	5	090009
M.1020	2 frese ø 2,3 mm - sfera - gambo ø 2,35 mm	5	090016
M.1070	2 frese ø 1,4 mm - cilindrica - gambo ø 2,35 mm	5	090023
M.1080	2 frese ø 2,3 mm - cilindrica - gambo ø 2,35 mm	5	090030
M.1120	2 frese ø 1,4 mm - cono rovesciato - gambo ø 2,35 mm	5	090047
M.1130	2 frese ø 2,3 mm - cono rovesciato - gambo ø 2,35 mm	5	090054
M.1170	2 frese ø 2,3 mm - fiamma - gambo ø 2,35 mm	5	090061
M.1270	2 frese ø 2,3 mm - punta - gambo ø 2,35 mm	5	090078
M.1340	2 frese ø 2,3 mm - ruota - gambo ø 2,35 mm	5	090085



FRESE IN ACCIAIO

Per l'intaglio, l'incisione, la fresatura di precisione, la scanalatura e la svasatura di legno, fibra di vetro, metalli teneri e plastica

M.1030	ø 4,0 mm - sfera - gambo ø 2,35 mm	5	090092
M.1050	ø 6,0 mm - sfera - gambo ø 3,0 mm	5	090108
M.1065	ø 7,8 mm - ovale - gambo ø 3,20 mm	5	092928
M.1100	ø 6,0 mm - cilindrica - gambo ø 3,0 mm	5	090115
M.1105	ø 7,8 mm - cilindrica - gambo ø 3,20 mm	5	092935
M.1140	ø 4,0 mm - cono rovesciato - gambo ø 2,35 mm	5	090122
M.1190	ø 4,0 mm - conica fiamma - gambo ø 2,35 mm	5	090139
M.1240	ø 6,0 mm - conica - gambo ø 3,0 mm	5	090146
M.1310	ø 6,0 mm - punta - gambo ø 3,0 mm	5	090153
M.1370	ø 6,0 mm - ruota - gambo ø 3,0 mm	5	090160
M.1375	ø 9,5 mm - ruota - gambo ø 3,20 mm	5	092942

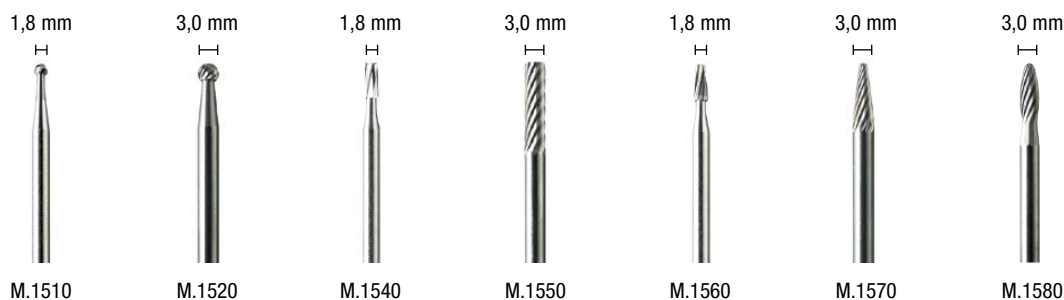
**FRESE AL CARBURO DI TUNGSTENO**

Per l'asportazione di materiale, la levigatura e la modellatura. Adatte per acciaio temprato, acciaio inox, ghisa, materiali non ferrosi, ceramica temprata, legno, plastica e altri materiali duri

M.1510	∅ 1,8 mm - sfera - gambo ∅ 2,35 mm	5	090177
M.1520	∅ 3,0 mm - sfera - gambo ∅ 3,0 mm	5	090184
M.1540	∅ 1,8 mm - cilindrica - gambo ∅ 2,35 mm	5	090191
M.1550	∅ 3,0 mm - cilindrica - gambo ∅ 3,0 mm	5	090207
M.1560	∅ 1,8 mm - conica - gambo ∅ 2,35 mm	5	090214
M.1570	∅ 3,0 mm - conica - gambo ∅ 3,0 mm	5	090221
M.1580	∅ 3,0 mm - fiamma - gambo ∅ 3,0 mm	5	090238

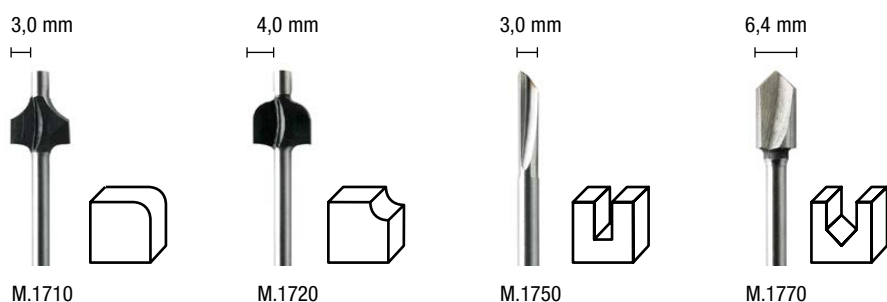
**FRESE IN HSS PER LEGNO**

Per rifinire bordi ed ottenere diversi tipi di scanalature e profili

M.1710	r = 3,0 mm - per profili convessi - gambo ∅ 3,0 mm	2	090320
M.1720	r = 4,0 mm - per profili concavi - gambo ∅ 3,0 mm	2	090337
M.1750	∅ 3,0 mm - per scanalature diritte - gambo ∅ 3,0 mm	2	090344
M.1770	∅ 6,4 mm - per scanalature a V - gambo ∅ 3,0 mm	2	090351



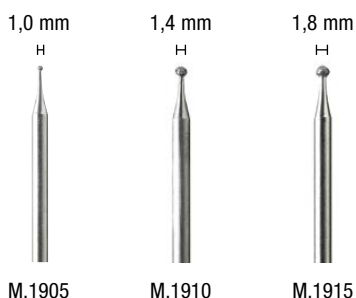

PUNTE DIAMANTATE

Rivestite con particelle di diamante, sono indicate per lavori di particolare precisione, quali l'incisione, l'intaglio, ritocchi o rifiniture su materiali come vetro, ceramica, pietre semipreziose, metalli, legno e altri materiali duri

M.1905	∅ 1,0 mm - sfera - gambo ∅ 2,35 mm	5	090245
M.1910	∅ 1,4 mm - sfera - gambo ∅ 2,35 mm	5	090252
M.1915	∅ 1,8 mm - sfera - gambo ∅ 2,35 mm	5	090269

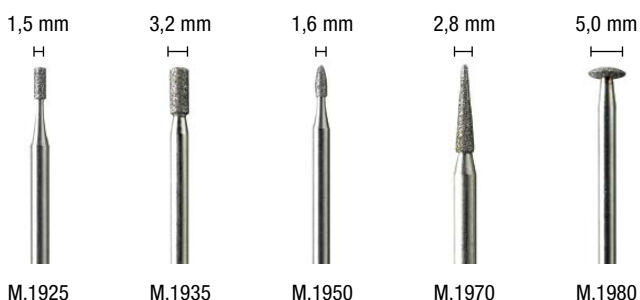

FRESE DIAMANTATE

Rivestite con particelle di diamante, sono indicate per lavori di particolare precisione, quali l'incisione, l'intaglio, ritocchi o rifiniture su materiali come vetro, ceramica, pietre semipreziose, metalli, legno e altri materiali duri

M.1925	∅ 1,5 mm - cilindrica - gambo ∅ 2,35 mm	5	090276
M.1935	∅ 3,2 mm - cilindrica - gambo ∅ 2,35 mm	5	090283
M.1950	∅ 1,6 mm - fiamma - gambo ∅ 2,35 mm	5	090290
M.1970	∅ 2,8 mm - punta - gambo ∅ 2,35 mm	5	090306
M.1980	∅ 5,0 mm - disco - gambo ∅ 2,35 mm	5	090313

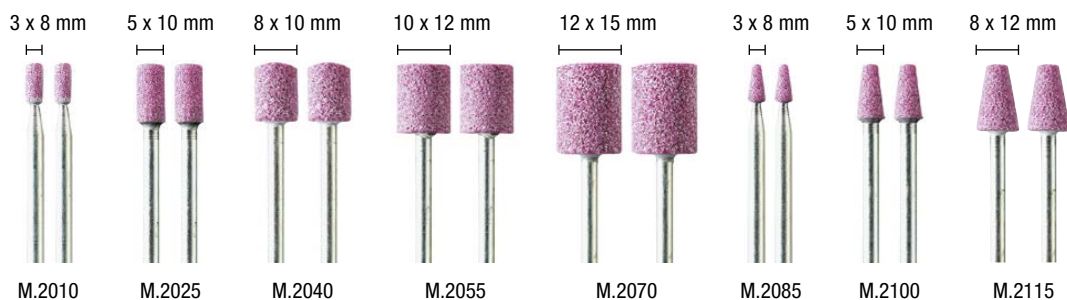
**MOLE ABRASIVE IN RUBINO**

Ad elevato potere abrasivo. Per l'affilatura, la sbavatura e lavori di smerigliatura della maggior parte dei materiali. Particolarmente indicate per lavori di rettifica di precisione

M.2010	2 mole \varnothing 3 x 8 mm - cilindrica - gambo \varnothing 3,0 mm	5	090368
M.2025	2 mole \varnothing 5 x 10 mm - cilindrica - gambo \varnothing 3,0 mm	5	090375
M.2040	2 mole \varnothing 8 x 10 mm - cilindrica - gambo \varnothing 3,0 mm	5	090382
M.2055	2 mole \varnothing 10 x 12 mm - cilindrica - gambo \varnothing 3,0 mm	5	090399
M.2070	2 mole \varnothing 12 x 15 mm - cilindrica - gambo \varnothing 3,0 mm	5	090405
M.2085	2 mole \varnothing 3 x 8 mm - conica - gambo \varnothing 2,35 mm	5	090412
M.2100	2 mole \varnothing 5 x 10 mm - conica - gambo \varnothing 2,35 mm	5	090429
M.2115	2 mole \varnothing 8 x 12 mm - conica - gambo \varnothing 3,0 mm	5	090436

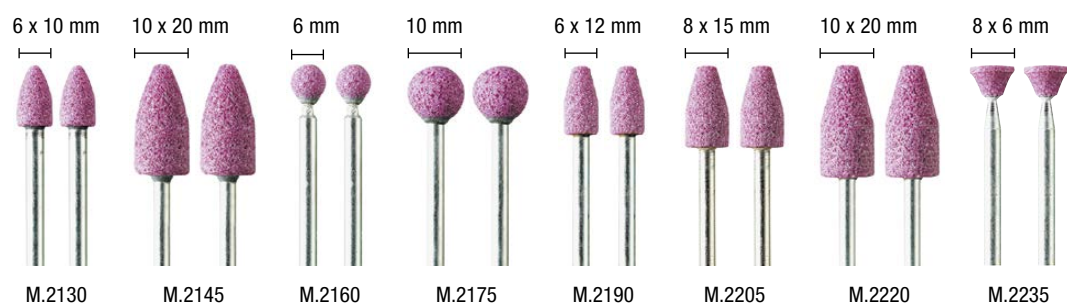
**MOLE ABRASIVE IN RUBINO**

Ad elevato potere abrasivo. Per l'affilatura, la sbavatura e lavori di smerigliatura della maggior parte dei materiali. Particolarmente indicate per lavori di rettifica di precisione

M.2130	2 mole \varnothing 6 x 10 mm - ogiva - gambo \varnothing 3,0 mm	5	090443
M.2145	2 mole \varnothing 10 x 20 mm - ogiva - gambo \varnothing 3,0 mm	5	090450
M.2160	2 mole \varnothing 6 mm - sfera - gambo \varnothing 3,0 mm	5	090467
M.2175	2 mole \varnothing 10 mm - sfera - gambo \varnothing 3,0 mm	5	090474
M.2190	2 mole \varnothing 6 x 12 mm - cilindrica conica - gambo \varnothing 3,0 mm	5	090481
M.2205	2 mole \varnothing 8 x 15 mm - cilindrica conica - gambo \varnothing 3,0 mm	5	090498
M.2220	2 mole \varnothing 10 x 20 mm - cilindrica conica - gambo \varnothing 3,0 mm	5	090504
M.2235	2 mole \varnothing 8 x 6 mm - conica rovesciata - gambo \varnothing 3,0 mm	5	090511





MOLE ABRASIVE IN CARBURO DI SILICIO

Ad elevatissimo potere abrasivo. Per l'affilatura di utensili in metallo duro. Adatte per l'incisione e la lavorazione di pietra, vetro, cristalli, ceramica e porcellana

M.2410	2 mole ø 3 x 8 mm - conica arrotondata - gambo ø 2,35 mm	5	090528
M.2420	2 mole ø 5 x 10 mm - conica arrotondata - gambo ø 2,35 mm	5	090535
M.2435	2 mole ø 4 mm - sfera - gambo ø 3,0 mm	5	090542
M.2450	2 mole ø 8 x 6 mm - conica rovesciata - gambo ø 3,0 mm	5	090559
M.2465	2 mole ø 6 x 10 mm - semi sfera - gambo ø 3,0 mm	5	090566
M.2480	2 mole ø 5 x 10 mm - fiamma - gambo ø 3,0 mm	5	090573

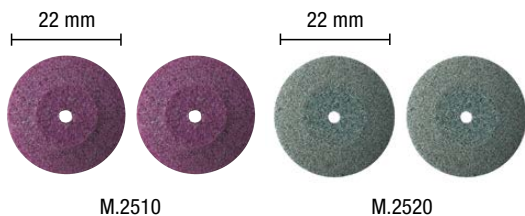

MOLE ABRASIVE LENTICOLARI

M.2510	2 mole ø 22 mm - in abrasivo rubino	5	090580
M.2520	2 mole ø 22 mm - in carburo di silicio	5	090597

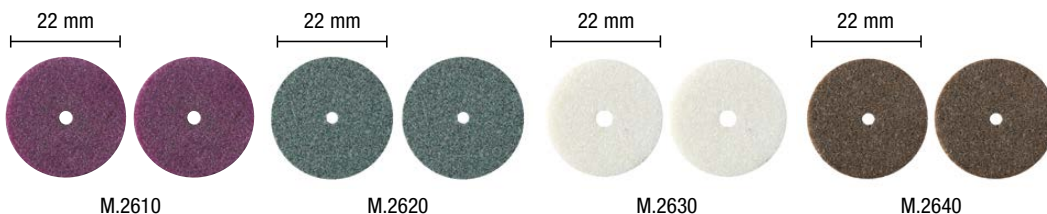

RUOTINE ABRASIVE

M.2610	2 mole ø 22 mm - in abrasivo rubino	5	090603
M.2620	2 mole ø 22 mm - in carburo di silicio	5	090610
M.2630	2 mole ø 22 mm - in abrasivo bianco	5	090627
M.2640	2 mole ø 22 mm - in abrasivo marrone	5	090634

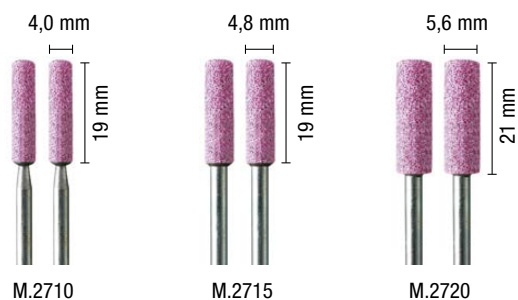
**MOLE ABRASIVE IN RUBINO PER AFFILATURA CATENE**

Ad alto potere abrasivo per l'affilatura di seghe a catena

M.2710	2 mole \varnothing 4,0 x 19 mm - cilindrica - gambo \varnothing 3,0 mm	5	090641
M.2715	2 mole \varnothing 4,8 x 19 mm - cilindrica - gambo \varnothing 3,0 mm	5	090658
M.2720	2 mole \varnothing 5,6 x 21 mm - cilindrica - gambo \varnothing 3,0 mm	5	090665

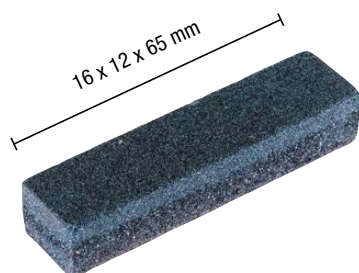
**RAVVIVAMOLE**

Per la ravnivatura, la pulitura e la rimodellatura delle mole abrasive

M.2910	16 x 12 x 65 mm - doppia grana	5	090672
---------------	--------------------------------	---	--------





20 mm - grana 80



M.3020

30 mm - grana 80



M.3030

RUOTE LAMELLARI ABRASIVE

Per levigare e lucidare superfici piane o di difficile accesso. Adatte per metallo, legno, gomma, plastica e per rimuovere la ruggine

M.3020	ø 20 x 5 mm - gambo ø 3,0 mm - grana 80	5	090689
M.3030	ø 30 x 10 mm - gambo ø 3,0 mm - grana 80	5	090696



M.3210

grana 100 - 220



20 mm - grana 100

10 x



M.3220

20 mm - grana 220

10 x



M.3230

PLATORELLO IN GOMMA E DISCHI ABRASIVI ADESIVI

Per levigare, smerigliare legno, plastica, gomma e rimuovere la ruggine dal metallo

M.3210	platorello in gomma ø 20 mm - gambo ø 3,2 mm - 6 dischi abrasivi - grane assortite	5	090702
M.3220	10 dischi abrasivi ø 20 mm - grana 100	5	090719
M.3230	10 dischi abrasivi ø 20 mm - grana 220	5	090726



M.3610

13 mm - grana 60

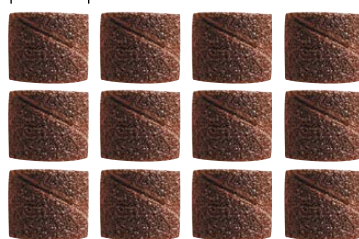

M.3620

13 mm - grana 120

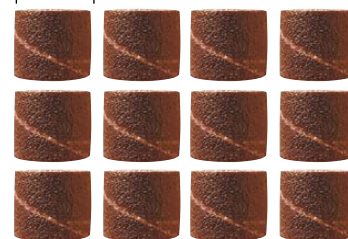

M.3630

SMERIGLIATORE AD ESPANSIONE E NASTRI ABRASIVI

Per levigare, smerigliare legno, plastica, gomma e rimuovere la ruggine dal metallo

M.3610	smerigliatore ad espansione ø 13 x 13 mm - gambo ø 3,2 mm	5	090733
M.3620	12 nastri abrasivi ø 13 mm - grana 60	5	090740
M.3630	12 nastri abrasivi ø 13 mm - grana 120	5	090757

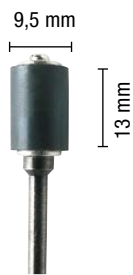

M.3640

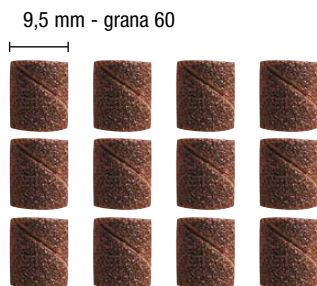

M.3650

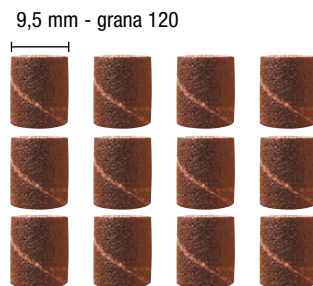

M.3660



SMERIGLIATORE AD ESPANSIONE E NASTRI ABRASIVI

Per levigare, smerigliare legno, plastica, gomma e rimuovere la ruggine dal metallo

M.3640	smerigliatore ad espansione \varnothing 9,5 x 13 mm - gambo \varnothing 3,2 mm	5	092959
M.3650	12 nastri abrasivi \varnothing 9,5 mm - grana 60	5	092966
M.3660	12 nastri abrasivi \varnothing 9,5 mm - grana 120	5	092973



M.3670

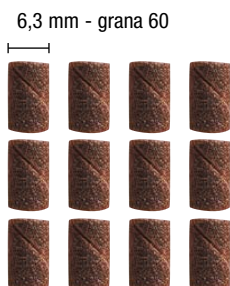

M.3680

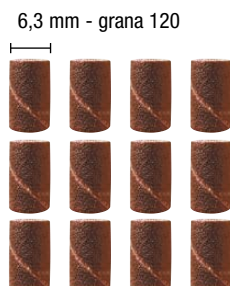

M.3690



SMERIGLIATORE AD ESPANSIONE E NASTRI ABRASIVI

Per levigare, smerigliare legno, plastica, gomma e rimuovere la ruggine dal metallo

M.3670	smerigliatore ad espansione \varnothing 6,3 x 13 mm - gambo \varnothing 3,2 mm	5	092980
M.3680	12 nastri abrasivi \varnothing 6,3 mm - grana 60	5	092997
M.3690	12 nastri abrasivi \varnothing 6,3 mm - grana 120	5	093000



SPAZZOLE IN ACCIAIO: per pulire e sbavare metallo, legno, plastica. Adatte per l'eliminazione di ruggine e corrosione, per la sbavatura e la pulitura di punti di saldatura

SPAZZOLE IN OTTONE: per pulire, sbavare e lucidare legno, metalli teneri, oro, rame e ottone senza produrre graffi. Indicate per la pulitura di componenti elettrici

M.4005	Ø 5 mm - pennello in acciaio - gambo Ø 2,35 mm	5	090764
M.4010	Ø 12 mm - tazza in acciaio - gambo Ø 2,35 mm	5	090771
M.4015	Ø 21 mm - circolare in acciaio - gambo Ø 2,35 mm	5	090788
M.4020	3 spazzole assortite in acciaio	5	090795
M.4055	Ø 5 mm - pennello in ottone - gambo Ø 2,35 mm	5	090801
M.4060	Ø 12 mm - tazza in ottone - gambo Ø 2,35 mm	5	090818
M.4065	Ø 21 mm - circolare in ottone - gambo Ø 2,35 mm	5	090825
M.4070	3 spazzole assortite in ottone	5	090832



SPAZZOLE IN SETOLA NERA: per tutti i lavori di leggera sbavatura, pulitura e lucidatura. Particolarmente indicate per argenteria, gioielli e altri materiali preziosi

SPAZZOLE IN NYLON BIANCO: per la pulizia e la lucidatura di metalli preziosi ed altre superfici delicate

M.4105	Ø 5 mm - pennello in setola nera - gambo Ø 2,35 mm	5	090849
M.4110	Ø 12 mm - tazza in setola nera - gambo Ø 2,35 mm	5	090856
M.4115	Ø 21 mm - circolare in setola nera - gambo Ø 2,35 mm	5	090863
M.4120	3 spazzole assortite in setola nera	5	090870
M.4155	Ø 5 mm - pennello in nylon bianco - gambo Ø 2,35 mm	5	090887
M.4160	Ø 12 mm - tazza in nylon bianco - gambo Ø 2,35 mm	5	090894
M.4165	Ø 21 mm - circolare in nylon bianco - gambo Ø 2,35 mm	5	090900
M.4170	3 spazzole assortite in nylon bianco	5	090917

**TAMPONI IN SILICONE BIANCO**

Lucidanti universali per la lisciatura di leghe preziose, ceramica, porcellane e smalti

M.4305	Ø 12 mm - disco - gambo Ø 2,35 mm	5	090924
M.4310	Ø 12 mm - lenticolare - gambo Ø 2,35 mm	5	090931

**PUNTE IN GOMMA BLU**

Per la finitura, la lucidatura, l'eliminazione di graffi e imperfezioni e la pulitura degli intagli su ceramica, materiali ferrosi e sulla maggior parte delle pietre

M.4505	Ø 6,0 mm - fiamma - gambo Ø 3,0 mm	5	090948
M.4510	Ø 5,0 mm - ogiva - gambo Ø 3,0 mm	5	090955
M.4515	Ø 6,0 mm - cilindrica - gambo Ø 3,0 mm	5	090962

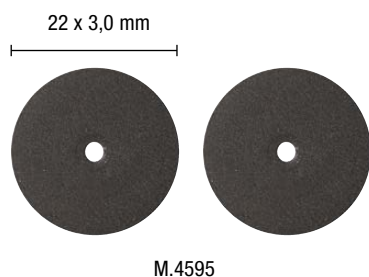
**DISCO IN GOMMA MARRONE**

Per lucidare ed eliminare graffi su materiali ferrosi, pietre e ceramiche

M.4595	2 dischi Ø 22 x 3,0 mm	5	090979
---------------	------------------------	---	--------



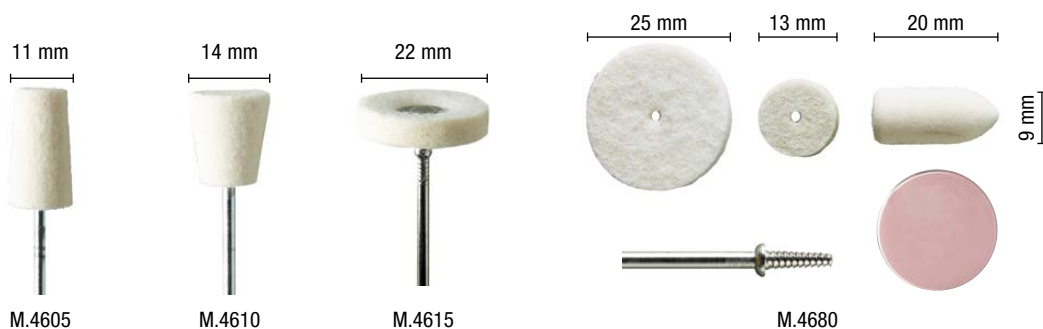

DISCHI IN FELTRO

Per la lucidatura di metalli, vetro, ceramica, metalli preziosi, pietre e plastica

M.4605	ø 11 mm - cono - gambo ø 2,35 mm	5	090986
M.4610	ø 14 mm - cono rovesciato - gambo ø 2,35 mm	5	090993
M.4615	ø 22 mm - ruota - gambo ø 2,35 mm	5	091006
M.4680	kit 3 feltri assortiti + alberino a piramide + pasta rosa	5	091013

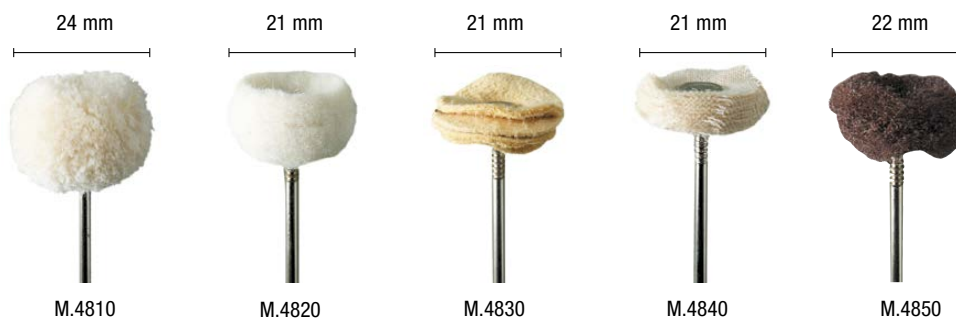

DISCHI IN COTONE, FELTRO MORBIDO, CAMOSCIO E IN LAMELLE DI COTONE:
per la lucidatura di metalli, oro, argento, metalli non ferrosi, ottone, alluminio, vetro

DISCO ABRASIVO "SCOTCH FABRIC": per la pulitura e la satinatura di vetro, legno, plastica, alluminio, acciaio, acciaio inox e altri metalli

M.4810	ø 24 mm - in cotone morbido - gambo ø 2,35 mm	5	091020
M.4820	ø 21 mm - in feltro morbido - gambo ø 2,35 mm	5	091037
M.4830	ø 21 mm - in camoscio - gambo ø 2,35 mm	5	091044
M.4840	ø 21 mm - in lamelle di cotone - gambo ø 2,35 mm	5	091051
M.4850	ø 22 mm - in abrasivo "scotch fabric" - gambo ø 2,35 mm	5	091068



PASTE PER LUCIDATURA

Da abbinare agli accessori in feltro e cotone. Per eliminare superfici appannate ed ossidate e/o leggere irregolarità superficiali

M.4905	pasta rosa per pre-lucidatura - universale	5	091075
M.4910	pasta bianca per lucidatura finale - universale	5	091082
M.4915	pasta abrasiva rossa per rame, ottone, bronzo	5	091099

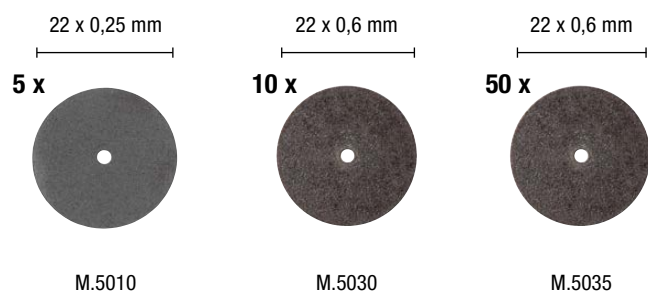
**DISCHI DA TAGLIO**

M.5010 Adatti al taglio e alla scanalatura del vetro, lamiere, legno sottile e plastica

M.5030 - M.5035 Ideali per il taglio o la scanalatura di bulloni, viti, lamiere metalliche, legno sottile e plastica

M.5010	5 dischi ø 22 x 0,25 mm - slim	5	091105
M.5030	10 dischi ø 22 x 0,6 mm	5	091112
M.5035	50 dischi ø 22 x 0,6 mm	5	091129

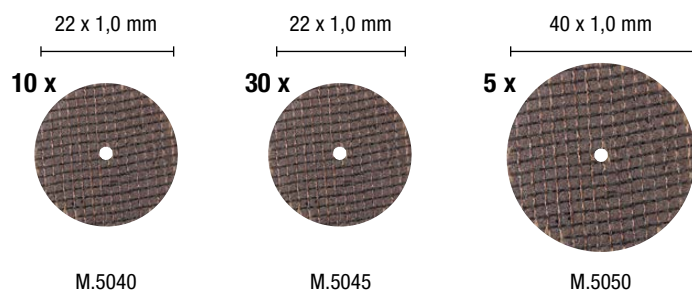
**DISCHI DA TAGLIO RINFORZATI**

Ideali per il taglio o la scanalatura di bulloni, viti, lamiere metalliche, legno sottile e plastica

M.5040	10 dischi ø 22 x 1,0 mm	5	093680
M.5045	30 dischi ø 22 x 1,0 mm	5	093697
M.5050	5 dischi ø 40 x 1,0 mm	5	091136

**DISCHI PER SGROSSARE**

Per la sgrossatura e la scanalatura di metalli, ceramica e plastica

M.5130	2 dischi ø 32 x 2,2 mm	5	091143
---------------	------------------------	---	--------



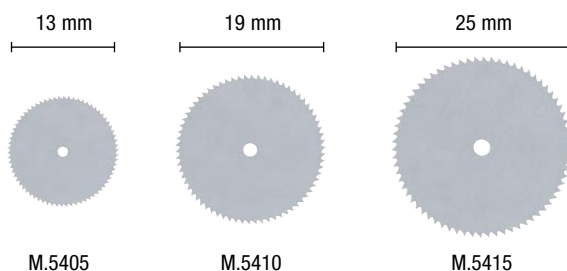

MINI LAME IN ACCIAIO

Per tagliare plastica (schede elettroniche), legno e metalli non ferrosi

M.5405	∅ 13 mm	5	091150
M.5410	∅ 19 mm	5	091167
M.5415	∅ 25 mm	5	091174

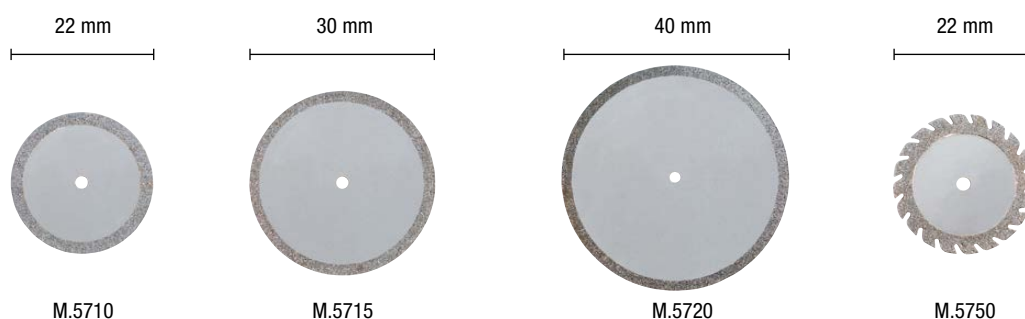

DISCO DIAMANTATO

Per tagliare e smerigliare materiali più duri del metallo, come marmo, pietra, porcellana, ceramica e resine dure. Estrema precisione nel taglio e lunga durata

M.5710	∅ 22 mm	5	091181
M.5715	∅ 30 mm	5	093314
M.5720	∅ 40 mm	5	093321
M.5750	∅ 22 mm - segmentato	5	093338

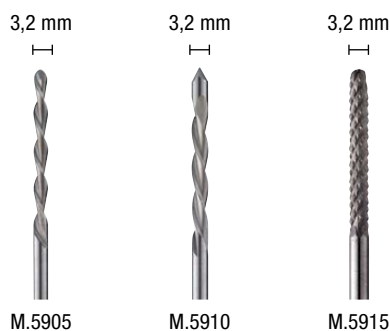

PUNTE DA TAGLIO A SPIRALE

M.5905 Per tagliare legno, plastica e fibra di vetro

M.5910 Per tagliare cartongesso

M.5915 Per tagliare piastrelle di ceramica, gesso e pannelli di cemento

M.5905	∅ 3,2 mm - gambo ∅ 3,2 mm	5	093345
M.5910	∅ 3,2 mm - gambo ∅ 3,2 mm	5	093352
M.5915	∅ 3,2 mm - gambo ∅ 3,2 mm	5	093369

Una gamma completa di punte HSS per forare con precisione legno, metallo e plastica

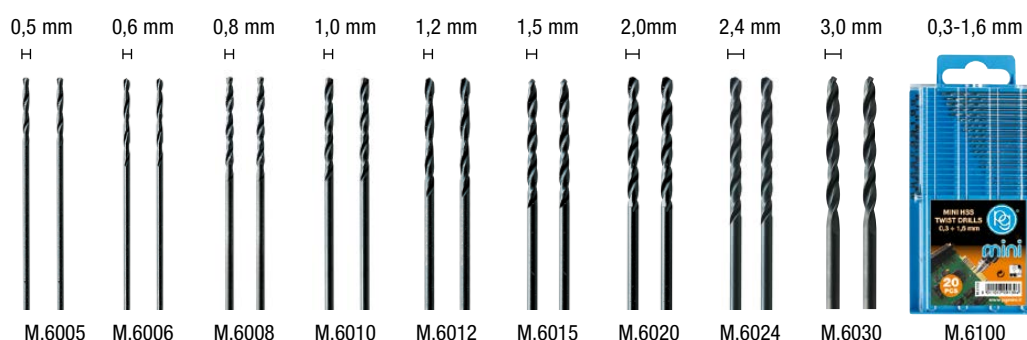

PUNTE IN ACCIAIO HSS

M.6005	2 punte \varnothing 0,5 mm	5	091198
M.6006	2 punte \varnothing 0,6 mm	5	091204
M.6008	2 punte \varnothing 0,8 mm	5	091211
M.6010	2 punte \varnothing 1,0 mm	5	091228
M.6012	2 punte \varnothing 1,2 mm	5	091235
M.6015	2 punte \varnothing 1,5 mm	5	091242
M.6020	2 punte \varnothing 2,0 mm	5	091259
M.6024	2 punte \varnothing 2,4 mm	5	091266
M.6030	2 punte \varnothing 3,0 mm	5	091273
M.6100	kit 20 punte \varnothing 0,3 - 0,35 - 0,4 - 0,45 - 0,5 - 0,55 - 0,6 - 0,65 - 0,7 - 0,75 - 0,8 - 0,85 - 0,9 - 0,95 - 1,0 - 1,2 - 1,3 - 1,4 - 1,5 - 1,6 mm	2	091396

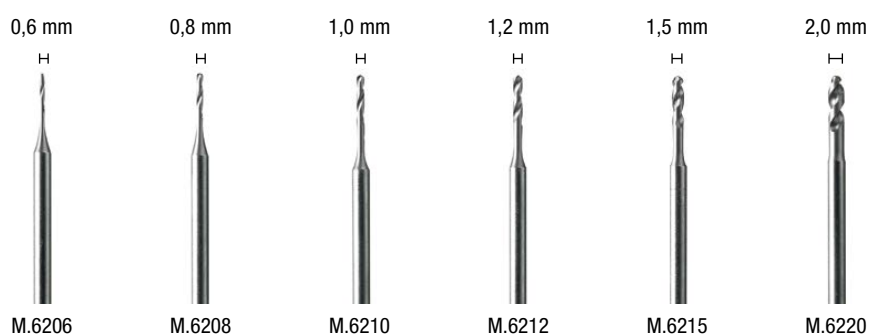

PUNTE IN ACCIAIO HSS RINFORZATE

M.6206	\varnothing 0,6 mm - gambo \varnothing 2,35 mm	5	091280
M.6208	\varnothing 0,8 mm - gambo \varnothing 2,35 mm	5	091297
M.6210	\varnothing 1,0 mm - gambo \varnothing 2,35 mm	5	091303
M.6212	\varnothing 1,2 mm - gambo \varnothing 2,35 mm	5	091310
M.6215	\varnothing 1,5 mm - gambo \varnothing 2,35 mm	5	091327
M.6220	\varnothing 2,0 mm - gambo \varnothing 2,35 mm	5	091334



1,0 mm 1,5 mm 2,35 mm 3,0 mm 3,2 mm



M.8010 (Minicraft, PG Mini, Proxxon)

0,8 mm 2,35 mm 3,0 mm 3,2 mm



M.8020 (B&D, Dremel)

PINZE

M.8010	kit pinze ø 1,0 - 1,5 - 2,35 - 3,0 - 3,2 mm e ghiera di serraggio	2	093017
M.8020	kit pinze ø 0,8 - 2,35 - 3,0 - 3,2 mm e ghiera di serraggio	2	093024



M.8100



M.8110



M.8120

ALBERINI

M.8100	alberino a vite - gambo ø 3,0 mm	5	091358
M.8110	alberino rinforzato a vite - gambo ø 2,35 mm	5	091365
M.8120	alberino a piramide - gambo ø 3,0 mm	5	091372



CAVO PROLUNGA

M.8305	cavo prolunga 5 m	1	091402
---------------	-------------------	---	--------

codice

caratteristiche

q.tà
imballo

EAN13
8011017

ACCESSORI VARI



M.8210

M.8210 kit 10 accessori per incisioni

2

093031

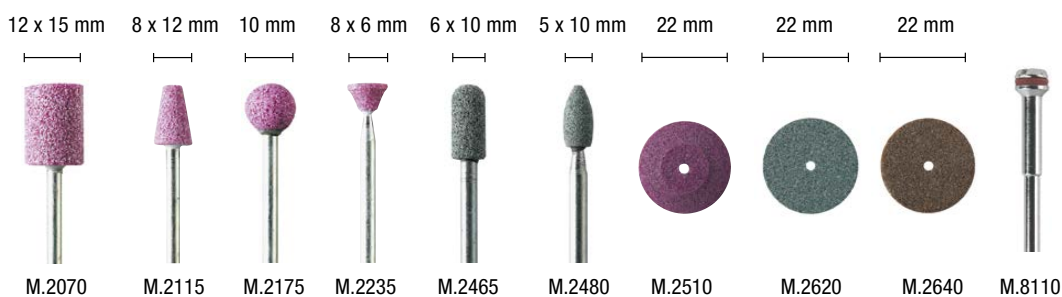

M.8230

M.8230 kit 10 accessori per smerigliatura ed affilatura

2

093048

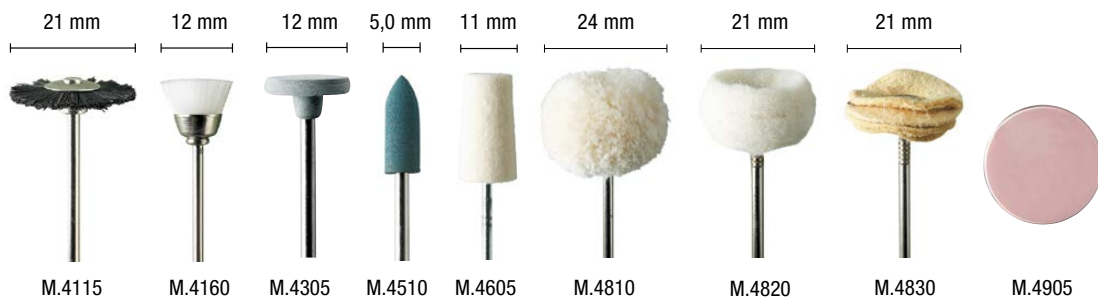

M.8250

M.8250 kit 9 accessori per lucidatura e pulitura

2

093055

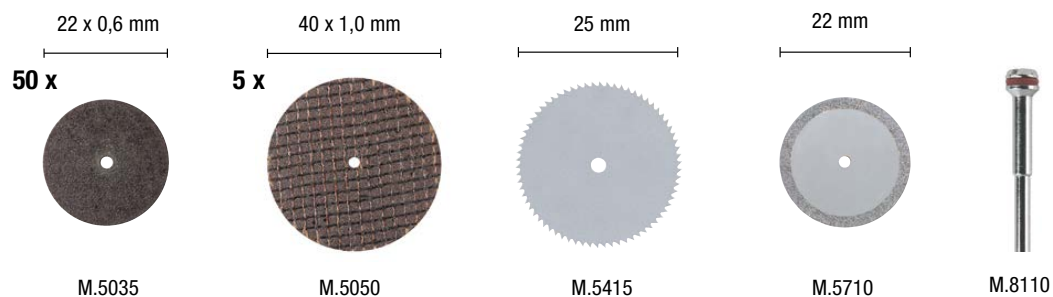

M.8270

M.8270 kit 58 accessori per taglio

2

093062





ALBERO FLESSIBILE per lavori accurati e di precisione in punti difficilmente accessibili

M.8500	- lunghezza 80 cm - con 3 pinze assortite (ø 2,35 - 3,0 - 3,2 mm) e 1 ghiera - 30.000 RPM	1	091426
---------------	---	----------	--------



0,4-3,2 mm



M.8550 (Minicraft, PG Mini, Proxxon)

0,4-3,2 mm



M.8560 (B&D, Dremel)

0,4-6,0 mm



M.8580 (M.9400, M.9500, M.9600)

MANDRINI

M.8550	mandrino autoserrante ø 0,4-3,2 mm - filettatura 8 x 0,75 - 10.000 RPM	1	091389
M.8560	mandrino autoserrante ø 0,4-3,2 mm - filettatura 9/32" x 40 - 10.000 RPM	1	093376
M.8580	mandrino a cremagliera con chiave e adattatore - ø 0,4-6,0 mm - filettatura 8 x 0,75 - 10.000 RPM	1	093598



MINI BOX PORTA ACCESSORI

M.BOX01	- modulare, in plastica antiurto - con rinforzi in gomma morbida antiscivolo - dimensioni 16,5 x 12 x 6,5 cm	1	088228
----------------	---	----------	--------



M.8600



M.8710



SUPPORTI ORIENTABILI PER MINI TRAPANO

M.8600	- posizionamento multidirezionale del trapano - ideale con l'albero flessibile art. M.8500 - collare ø 43 mm + collare di riduzione ø 33 mm	1	091433
M.8710	collare girevole ø 32/48 mm - inclinazione e altezza regolabili - scorrimento a cremagliera con molla di ritorno e arresto di profondità - altezza 260 mm - corsa 27 mm - luce (distanza albero/centro mandrino) 115 mm - altezza lavoro 100 mm - asta ø 16 mm - base in alluminio 250 x 180 mm	1	093666



MINI MORSA

M.8750	- larghezza 45 mm - apertura 50 mm	1	093383
---------------	---	---	--------



KIT SVITA E AVVITA DI PRECISIONE - 45 PEZZI

M.8775	1 flessibile - 1 pinza di precisione 35 inserti assortiti - 1 cacciavite - 7 bussole	1	093574
---------------	--	---	--------



**KIT CUTTER DI PRECISIONE - 18 PEZZI**

Ideali per lavori di precisione su plastica, pannelli in ABS, legno, compensato, carta e cartone

M.8790

- 1 impugnatura in bi-materiale antiscivolo per materiali leggeri e medi, con attacco rapido delle lame
- 1 impugnatura in bi-materiale antiscivolo per materiali spessi, con attacco rapido delle lame
- 14 lame di precisione assortite
- 1 cacciavite di precisione
- 1 pinza di precisione

1

093581



Voltaggio	230 V / 50 Hz
Potenza	30 Watt
Temperatura	450/500 °C
Lung. cavo	1,2 m
Peso	94 g

PIROGRAFO

Per incidere legno, cuoio naturale, zucche, carta spessa, vimini e rattan

M.8800

- corpo in ABS
- con 2 punte (universale e conica)
- con supporto di appoggio

1

093550

PISTOLE TERMOCOLLANTI

Ugello con protezione termica, dispositivo antigoccia. Ad avanzamento automatico. Corpo in plastica antiurto. Per incollare carta, plastica, legno, ceramica, tessuti



Voltaggio **230 V / 50 Hz**
Potenza **20 Watt**
Lung. cavo **1,8 m**
Peso **170 g**



M.8820 pistola termocollante con **2** stick di colla ø **7** mm 1 093529



Voltaggio **230 V / 50 Hz**
Potenza **30 Watt**
Lung. cavo **1,8 m**
Peso **200 g**



M.8815 - pistola termocollante con **2** stick di colla ø **7** mm
- con pulsante di accensione/spegnimento
- base di appoggio autoportante 1 093703



Voltaggio **230 V / 50 Hz**
Potenza **60 Watt**
Lung. cavo **1,8 m**
Peso **330 g**

M.8845 - pistola termocollante con **2** stick di colla ø **11** mm
- con pulsante di accensione/spegnimento
- base di appoggio autoportante 1 093710



STICK COLLA A CALDO

M.8822 **12** stick di colla ø **7** mm - lunghezza **100** mm 10 600000

M.8857 **12** stick di colla ø **11** mm - lunghezza **100** mm 10 600208





Voltaggio	230 V / 50 Hz
Voltaggio secondario	15 V DC
Uscite	max 12 VA
Velocità	singola *
Lunghezza cavo	2 m
Peso	520 g

* la velocità dipende dall'utensile impiegato

TRASFORMATORE AD UNA VELOCITÀ

M.9000	- potenza sufficiente per tutti gli utensili da 6, 25, 30 e 40 Watt	1	091440
	- protezione anti-sovraccarico per una maggiore sicurezza e una più lunga durata dell'utensile stesso		



Voltaggio	0-18 Vcc
Potenza	6 Watt
Velocità a vuoto	0-17.000 RPM
Capacità porta punta	ø 2,35 mm
Lunghezza cavo	1,8 m
Peso	75 g

PENNA PER INCISIONI

M.9200	- design a penna per un comodo utilizzo	1	091488
	- interruttore ON/OFF a sfioramento per un agevole impiego		
	- semplice cambio degli accessori ad incastro		
	- rotazione veloce per un efficace lavoro di incisione		
	- dotato di 1 punta diamantata		
	- disponibile in kit art. M.9250		



Voltaggio	230 V / 50 Hz
Potenza	6 Watt
Velocità a vuoto	0-17.000 RPM
Capacità porta punte	Ø 2,35 mm
Lunghezza cavo	1,8 m
Peso	220 g

PENNA PER INCISIONI CON TRASFORMATORE

M.9220	<ul style="list-style-type: none"> - design a penna per un comodo utilizzo - interruttore ON/OFF a sfioramento per un agevole impiego - semplice cambio degli accessori ad incastro - rotazione veloce per un efficace lavoro di incisione - dotato di 1 punta diamantata - disponibile in kit art. M.9250 	1	093628



KIT PER INCISIONI 6 W

M.9250	<ul style="list-style-type: none"> - penna per incisioni art. M.9200 - trasformatore a spina - 1 punta diamantata - 3 mole su perno - 2 stencil - comoda valigetta 	1	091495



Voltaggio	0-18 V DC
Potenza	30 Watt
Velocità a vuoto	0-30.000 RPM
Tipo di mandrino	autoserrante
Capacità mandrino	Ø 0,4-3,2 mm
Lunghezza cavo	1,8 m
Peso	125 g

TRAPANO AD ALTA COPPIA

M.9100	<ul style="list-style-type: none"> - mandrino autoserrante per agevolare il cambio degli accessori - alta velocità per svariate applicazioni - impugnatura a penna per facilitarne l'impiego - dotato di 3 pinze assortite (Ø 2,35 - 3,0 - 3,2 mm) e 1 ghiera per una maggiore flessibilità - disponibile in kit art. M.9150 	1	091464



KIT MINI TRAPANO 30 W

M.9150	<ul style="list-style-type: none"> - trapano ad alta coppia art. M.9100 - trasformatore ad una velocità art. M.9000 - 29 accessori selezionati - comoda valigetta 	1	091471

codice

caratteristiche

q.tà
imballo

EAN13
8011017

**TRAPANI
TRASFORMATORI
KIT**



Voltaggio	230 V / 50 Hz
Potenza	60 Watt
Velocità a vuoto	8.000-18.000 RPM
Tipo di mandrino	pinza
Lunghezza cavo	1,8 m
Peso	805 g

TRAPANO DI PRECISIONE CON TRASFORMATORE

M.9300	<ul style="list-style-type: none"> - corpo ergonomicamente progettato per una comoda impugnatura - velocità variabile per una maggiore precisione - pulsante di blocco albero - dotato di 5 pinze assortite (\varnothing 1,0 - 1,5 - 2,35 - 3,0 - 3,2 mm) e 1 ghiera per una maggiore flessibilità - disponibile in kit art. M.9350 	1	093604



KIT MINI TRAPANO DI PRECISIONE 60 W

M.9350	<ul style="list-style-type: none"> - trapano di precisione art. M.9300 - trasformatore - 62 accessori selezionati - comoda valigetta 	1	093611



Voltaggio	230 V / 50 Hz
Potenza	130 Watt
Velocità a vuoto	8.000-32.000 RPM
Tipo di mandrino	autoserrante
Capacità mandrino	Ø 0,4-3,2 mm
Lunghezza cavo	1,9 m
Peso	630 g

TRAPANO AD ALTA COPPIA

M.9500

- mandrino autoserrante per agevolare il cambio degli accessori
- corpo ergonomicamente progettato per una comoda impugnatura
- motore potente e velocità variabile per svariate applicazioni
- pulsante di blocco albero
- dotato di **3** pinze assortite (Ø **2,35 - 3,0 - 3,2 mm**) e **1** ghiera per una maggiore flessibilità
- non richiede trasformatore
- disponibile in kit art. **M.9550**

1

093116



KIT TRAPANO ALTA COPPIA 130 W

M.9550

- trapano a velocità variabile ad alta coppia art. **M.9500**
- **60** accessori selezionati
- comoda valigetta

1

093123



Voltaggio	230 V / 50 Hz
Potenza	170 Watt
Velocità a vuoto	8.000-32.000 RPM
Tipo di mandrino	autoserrante
Capacità mandrino	Ø 0,4-3,2 mm
Lunghezza cavo	1,9 m
Peso	665 g



TRAPANO AD ALTA COPPIA

M.9600	<ul style="list-style-type: none"> - mandrino autoserrante per agevolare il cambio degli accessori - display digitale/controllo velocità: per lavorazioni più precise sui diversi materiali - corpo ergonomicamente progettato per una comoda impugnatura - motore potente e velocità variabile per svariate applicazioni - pulsante di blocco albero - dotato di 3 pinze assortite (Ø 2,35 - 3,0 - 3,2 mm) e 1 ghiera per una maggiore flessibilità - non richiede trasformatore - disponibile in kit art. M.9650 	1	093413



KIT TRAPANO ALTA COPPIA DISPLAY LCD 170 W

M.9650	<ul style="list-style-type: none"> - trapano a velocità variabile con display digitale art. M.9600 - 60 accessori selezionati - comoda valigetta 	1	093420



Totale referenze 36		Totale pezzi 162	
5x M.1010	5x M.1030	5x M.1080	5x M.1100
5x M.2040	5x M.2070	5x M.2100	5x M.2410
5x M.3630	5x M.4020	5x M.4070	5x M.4680
5x M.5415	5x M.5710	5x M.5715	4x M.8010
5x M.5010	5x M.5030	5x M.5050	5x M.5410
4x M.8020	5x M.8100	5x M.8110	4x M.6100
5x M.1240	5x M.1270	5x M.1915	5x M.1970
5x M.3030	5x M.3210	5x M.3610	5x M.3620
1x M.9150	2x M.9250	1x M.9350	1x M.9550

ESPOSITORE DA BANCO*

ESPO.M3A

- altezza **82** cm
- larghezza **46** cm
- profondità **32** cm

1

093727



Totale referenze 32		Totale pezzi 141	
5x M.1010	5x M.1030	5x M.1080	5x M.1100
5x M.2070	5x M.2100	5x M.2610	5x M.3030
5x M.4020	5x M.4070	5x M.4680	5x M.5030
5x M.5050	5x M.5410	5x M.5710	5x M.8100
4x M.8210	4x M.8230	4x M.8250	4x M.8270
1x M.9150	2x M.9250	1x M.9350	1x M.9550
5x M.1240	5x M.1270	5x M.1915	5x M.1970
5x M.3640	5x M.3650	5x M.3660	

ESPOSITORE DA BANCO*

ESPO.M3B

- altezza **85** cm
- larghezza **46** cm
- profondità **32** cm

1

093734



**Totale
referenze
148**

**Totale
pezzi
709**

Totale referenze: 148		Totale pezzi: 709	
mini			
4x M. 6100	5x M. 4680	5x M. 2910	5x M. 1010
5x M. 6005	5x M. 4810	5x M. 3020	5x M. 1020
5x M. 6006	5x M. 4820	5x M. 3030	5x M. 1070
5x M. 6008	5x M. 4830	5x M. 3210	5x M. 1080
5x M. 6010	5x M. 4840	5x M. 3220	5x M. 1120
5x M. 6012	5x M. 4850	5x M. 3230	5x M. 1170
5x M. 6020	5x M. 4905	5x M. 3610	5x M. 1270
5x M. 6206	5x M. 4910	5x M. 3620	5x M. 1030
5x M. 6208	5x M. 4915	5x M. 3630	5x M. 1050
5x M. 6210	5x M. 5010	5x M. 3640	5x M. 1065
5x M. 6212	5x M. 5030	5x M. 3650	5x M. 1100
5x M. 6215	5x M. 5050	5x M. 3660	5x M. 1105
4x M. 8010	5x M. 5130	5x M. 3670	5x M. 1190
4x M. 8020	5x M. 5405	5x M. 3680	5x M. 1240
5x M. 8100	5x M. 5410	5x M. 3690	5x M. 1310
5x M. 8110	5x M. 5415	5x M. 4005	5x M. 1375
5x M. 8120	5x M. 5710	5x M. 4010	5x M. 1510
4x M. 8550	5x M. 5715	5x M. 4605	5x M. 1540
4x M. 8560	5x M. 5720	5x M. 4610	5x M. 1550
4x M. 8580	5x M. 5730	5x M. 4615	5x M. 1580
3x M. 9300	3x M. 9500	3x M. 9600	
4x M. 8210	4x M. 8230	4x M. 8250	
4x M. 8270	3x M. 8800	3x M. 8500	
3x M. 8790	3x M. 8775	3x M. 8815	
3x M. 8845	20x M. 8857	20x M. 8822	
2x M. 9250	2x M. 9150	2x M. 8710	
2x M. 9650	2x M. 9350	2x M. 9550	

ESPOSITORE DA PARETE*

ESPO.M3C	- altezza 206 cm	1	093741
	- larghezza 100 cm		
	- profondità 40 cm		

* La composizione base degli espositori è personalizzabile.

INDICE NUMERICO: ARTICOLI, QUANTITÀ E CODICI A BARRE

Anteporre al codice EAN il prefisso 8011017

ref.	descrizione	☐	ean	pag.	ref.	descrizione	☐	ean	pag.
10.010	2 PUNTE HSS 1 MM	10	100104	86	13.555	SEGA A TAZZA BIMETAL 30MM	1	135557	73
10.015	2 PUNTE HSS 1,5 MM	10	100159	86	13.560	SEGA A TAZZA BIMETAL 32MM	1	135601	73
10.020	2 PUNTE HSS 2 MM	10	100203	86	13.565	SEGA A TAZZA BIMETAL 33MM	1	135656	73
10.025	2 PUNTE HSS 2,5 MM	10	100258	86	13.570	SEGA A TAZZA BIMETAL 35MM	1	135700	73
10.030	2 PUNTE HSS 3 MM	10	100302	86	13.575	SEGA A TAZZA BIMETAL 37MM	1	135755	73
10.035	2 PUNTE HSS 3,5 MM	10	100357	86	13.580	SEGA A TAZZA BIMETAL 38MM	1	135809	73
10.040	2 PUNTE HSS 4 MM	10	100401	86	13.585	SEGA A TAZZA BIMETAL 40MM	1	135854	73
10.045	PUNTA HSS 4,5 MM	10	100456	86	13.590	SEGA A TAZZA BIMETAL 41MM	1	135908	73
10.050	PUNTA HSS 5 MM	10	100500	86	13.595	SEGA A TAZZA BIMETAL 43MM	1	135953	73
10.055	PUNTA HSS 5,5 MM	10	100555	86	13.600	SEGA A TAZZA BIMETAL 44MM	1	136004	73
10.060	PUNTA HSS 6 MM	10	100609	86	13.605	SEGA A TAZZA BIMETAL 46MM	1	136059	73
10.065	PUNTA HSS 6,5 MM	10	100654	86	13.610	SEGA A TAZZA BIMETAL 48MM	1	136103	73
10.070	PUNTA HSS 7 MM	10	100708	86	13.615	SEGA A TAZZA BIMETAL 51MM	1	136158	73
10.075	PUNTA HSS 7,5 MM	10	100753	86	13.620	SEGA A TAZZA BIMETAL 52MM	1	136202	73
10.080	PUNTA HSS 8 MM	10	100807	86	13.625	SEGA A TAZZA BIMETAL 54MM	1	136257	73
10.085	PUNTA HSS 8,5 MM	10	100852	86	13.630	SEGA A TAZZA BIMETAL 57MM	1	136301	73
10.090	PUNTA HSS 9 MM	10	100906	86	13.635	SEGA A TAZZA BIMETAL 59MM	1	136356	73
10.095	PUNTA HSS 9,5 MM	10	100951	86	13.640	SEGA A TAZZA BIMETAL 60MM	1	136400	73
10.100	PUNTA HSS 10 MM	10	101002	86	13.645	SEGA A TAZZA BIMETAL 64MM	1	136455	73
10.105	PUNTA HSS 10,5MM	10	101057	86	13.650	SEGA A TAZZA BIMETAL 65MM	1	136509	73
10.110	PUNTA HSS 11 MM	10	101101	86	13.655	SEGA A TAZZA BIMETAL 67MM	1	136554	73
10.115	PUNTA HSS 11,5MM	10	101156	86	13.660	SEGA A TAZZA BIMETAL 70MM	1	136608	73
10.120	PUNTA HSS 12 MM	10	101200	86	13.665	SEGA A TAZZA BIMETAL 73MM	1	136653	73
10.125	PUNTA HSS 12,5MM	10	101255	86	13.670	SEGA A TAZZA BIMETAL 76MM	1	136707	73
10.130	PUNTA HSS 13 MM	10	101309	86	13.675	SEGA A TAZZA BIMETAL 79MM	1	136752	73
103.1/4	FRESA HOBBY ESTERNA 1/2	10	103143	8	13.680	SEGA A TAZZA BIMETAL 83MM	1	136806	73
103.6MA	FRESA HOBBY ESTERNA 1/2	10	103006	8	13.685	SEGA A TAZZA BIMETAL 86MM	1	136851	73
11.010	FRESA 10MM 6MA	10	110103	9	13.690	SEGA A TAZZA BIMETAL 89MM	1	136905	73
11.012	FRESA 12MM 6MA	10	110127	9	13.695	SEGA A TAZZA BIMETAL 92MM	1	136950	73
11.014	FRESA 14MM 6MA 3/8	10	110141	9	13.700	SEGA A TAZZA BIMETAL 95MM	1	137001	73
11.017	FRESA 17MM 6MA 1/2	10	110172	9	13.705	SEGA A TAZZA BIMETAL 98MM	1	137056	73
11.024	FRESA 24MM 6MA 3/4	10	110240	9	13.710	SEGA A TAZZA BIMETAL 102MM	1	137100	73
11.028	FRESA 28MM 6MA 1"	10	110288	9	13.715	SEGA A TAZZA BIMETAL 105MM	1	137155	73
11.034	FRESA 34MM 1/4 1"1/8	5	110349	9	13.720	SEGA A TAZZA BIMETAL 108MM	1	137209	73
11.038	FRESA 38MM 1/4 1"1/4	5	110387	9	13.725	SEGA A TAZZA BIMETAL 111MM	1	137254	73
11.043	FRESA 43MM 1/4 1"1/2	5	110431	9	13.730	SEGA A TAZZA BIMETAL 114MM	1	137308	73
11.055	FRESA 55MM 1/4 2"	5	110554	9	13.735	SEGA A TAZZA BIMETAL 121MM	1	137353	73
12.010	PUNTA FORSTNER 10MM	1	120102	42	13.740	SEGA A TAZZA BIMETAL 127MM	1	137407	73
12.012	PUNTA FORSTNER 12MM	1	120126	42	13.745	SEGA A TAZZA BIMETAL 140MM	1	137452	73
12.014	PUNTA FORSTNER 14MM	1	120140	42	13.750	SEGA A TAZZA BIMETAL 152MM	1	137506	73
12.015	PUNTA FORSTNER 15MM	1	120157	42	13.780	ALBERO PER BIMETAL 14/30MM	1	137803	72
12.016	PUNTA FORSTNER 16MM	1	120164	42	13.785	ALBERO PER BIMETAL 32/152MM	1	137858	72
12.018	PUNTA FORSTNER 18MM	1	120188	42	13.790	ALBERO PER BIMETAL 14/30MM	1	137902	72
12.020	PUNTA FORSTNER 20MM	1	120201	42	13.795	ALBERO PER BIMETAL 32/152MM	1	137957	72
12.022	PUNTA FORSTNER 22MM	1	120225	42	13.800	PUNTA ALBERO BIMETAL 115MM	1	138008	72
12.024	PUNTA FORSTNER 24MM	1	120249	42	13.805	PUNTA ALBERO BIMETAL 70MM	1	138053	72
12.025	PUNTA FORSTNER 25MM	1	120256	42	14.003	PUNTA LEGNO 3MM SFUSA	10	140032	88
12.026	PUNTA FORSTNER 26MM	1	120263	42	14.004	PUNTA LEGNO 4MM SFUSA	10	140049	88
12.028	PUNTA FORSTNER 28MM	1	120287	42	14.005	PUNTA LEGNO 5MM SFUSA	10	140056	88
12.030	PUNTA FORSTNER 30MM	1	120300	42	14.006	PUNTA LEGNO 6MM SFUSA	10	140063	88
12.032	PUNTA FORSTNER 32MM	1	120324	42	14.007	PUNTA LEGNO 7MM SFUSA	10	140070	88
12.034	PUNTA FORSTNER 34MM	1	120348	42	14.008	PUNTA LEGNO 8MM SFUSA	10	140087	88
12.035	PUNTA FORSTNER 35MM	1	120355	42	14.009	PUNTA LEGNO 9MM SFUSA	10	140094	88
12.036	PUNTA FORSTNER 36MM	1	120362	42	14.010	PUNTA LEGNO 10MM SFUSA	10	140100	88
12.040	PUNTA FORSTNER 40MM	1	120409	42	14.011	PUNTA LEGNO 11MM SFUSA	10	140117	88
12.045	PUNTA FORSTNER 45MM	1	120454	42	14.012	PUNTA LEGNO 12MM SFUSA	10	140124	88
12.050	PUNTA FORSTNER 50MM	1	120508	42	14.013	PUNTA LEGNO 13MM SFUSA	10	140131	88
13.500	SEGA A TAZZA BIMETAL 14MM	1	135007	73	14.014	PUNTA LEGNO 14MM SFUSA	10	140148	88
13.505	SEGA A TAZZA BIMETAL 16MM	1	135052	73	14.015	PUNTA LEGNO 15MM SFUSA	10	140155	88
13.510	SEGA A TAZZA BIMETAL 17MM	1	135106	73	14.016	PUNTA LEGNO 16MM SFUSA	10	140162	88
13.515	SEGA A TAZZA BIMETAL 19MM	1	135151	73	14.018	PUNTA LEGNO 18MM SFUSA	5	140186	88
13.520	SEGA A TAZZA BIMETAL 20MM	1	135205	73	14.020	PUNTA LEGNO 20MM SFUSA	5	140209	88
13.525	SEGA A TAZZA BIMETAL 21MM	1	135250	73	14.022	PUNTA LEGNO 22MM SFUSA	5	140223	88
13.530	SEGA A TAZZA BIMETAL 22MM	1	135304	73	14.024	PUNTA LEGNO 24MM SFUSA	5	140247	88
13.535	SEGA A TAZZA BIMETAL 24MM	1	135359	73	14.026	PUNTA LEGNO 26MM SFUSA	2	140261	88
13.540	SEGA A TAZZA BIMETAL 25MM	1	135403	73	14.028	PUNTA LEGNO 28MM SFUSA	2	140285	88
13.545	SEGA A TAZZA BIMETAL 27MM	1	135458	73	14.030	PUNTA LEGNO 30MM SFUSA	2	140308	88
13.550	SEGA A TAZZA BIMETAL 29MM	1	135502	73	14.206	PUNTA LEGNO 6X250MM	1	142067	88

INDICE NUMERICO: ARTICOLI, QUANTITÀ E CODICI A BARRE

Anteporre al codice EAN il prefisso 8011017

ref.	descrizione	☐	ean	pag.	ref.	descrizione	☐	ean	pag.
14.207	PUNTA LEGNO 7X250MM	1	142074	88	17.025	PUNTA HSS 2,5 MM SFUSA	10	170251	86
14.208	PUNTA LEGNO 8X250MM	1	142081	88	17.030	PUNTA HSS 3 MM SFUSA	10	170305	86
14.209	PUNTA LEGNO 9X250MM	1	142098	88	17.035	PUNTA HSS 3,5 MM SFUSA	10	170350	86
14.210	PUNTA LEGNO 10X250MM	1	142104	88	17.040	PUNTA HSS 4 MM SFUSA	10	170404	86
14.211	PUNTA LEGNO 11X250MM	1	142111	88	17.045	PUNTA HSS 4,5 MM SFUSA	10	170459	86
14.212	PUNTA LEGNO 12X250MM	1	142128	88	17.050	PUNTA HSS 5 MM SFUSA	10	170503	86
14.213	PUNTA LEGNO 13X250MM	1	142135	88	17.055	PUNTA HSS 5,5 MM SFUSA	10	170558	86
14.214	PUNTA LEGNO 14X250MM	1	142142	88	17.060	PUNTA HSS 6 MM SFUSA	10	170602	86
14.215	PUNTA LEGNO 15X250MM	1	142159	88	17.065	PUNTA HSS 6,5 MM SFUSA	10	170657	86
14.216	PUNTA LEGNO 16X250MM	1	142166	88	17.070	PUNTA HSS 7 MM SFUSA	10	170701	86
14.218	PUNTA LEGNO 18X250MM	1	142180	88	17.075	PUNTA HSS 7,5 MM SFUSA	10	170756	86
14.220	PUNTA LEGNO 20X250MM	1	142203	88	17.080	PUNTA HSS 8 MM SFUSA	10	170800	86
14.222	PUNTA LEGNO 22X250MM	1	142227	88	17.085	PUNTA HSS 8,5 MM SFUSA	10	170855	86
14.224	PUNTA LEGNO 24X250MM	1	142241	88	17.090	PUNTA HSS 9 MM SFUSA	10	170909	86
15.030	PUNTA WIDIA 3MM	10	150307	87	17.095	PUNTA HSS 9,5 MM SFUSA	10	170954	86
15.040	PUNTA WIDIA 4MM	10	150406	87	17.100	PUNTA HSS 10 MM SFUSA	10	171005	86
15.050	PUNTA WIDIA 5MM	10	150505	87	17.105	PUNTA HSS 10,5MM SFUSA	10	171050	86
15.060	PUNTA WIDIA 6MM	10	150604	87	17.110	PUNTA HSS 11 MM SFUSA	10	171104	86
15.070	PUNTA WIDIA 7MM	10	150703	87	17.115	PUNTA HSS 11,5MM SFUSA	10	171159	86
15.080	PUNTA WIDIA 8MM	10	150802	87	17.120	PUNTA HSS 12 MM SFUSA	10	171203	86
15.090	PUNTA WIDIA 9MM	10	150901	87	17.125	PUNTA HSS 12,5MM SFUSA	10	171258	86
15.100	PUNTA WIDIA 10MM	10	151007	87	17.130	PUNTA HSS 13 MM SFUSA	10	171302	86
15.120	PUNTA WIDIA 12MM	10	151205	87	17.135	PUNTA HSS 13,5MM SFUSA	5	171357	86
15.140	PUNTA WIDIA 14MM	10	151403	87	17.140	PUNTA HSS 14 MM SFUSA	5	171401	86
15.606	SET 5 PUNTE LEGNO 4/10MM	2	156064	85	17.145	PUNTA HSS 14,5MM SFUSA	5	171456	86
15.607	SET 8 PUNTE LEGNO 3/10MM	2	156071	85	17.150	PUNTA HSS 15 MM SFUSA	5	171500	86
15.608	SET 5 PUNTE MURO 4/10MM	2	156088	85	17.155	PUNTA HSS 15,5MM SFUSA	5	171555	86
15.610	SET 8 PUNTE MURO 3/10MM	2	156101	85	17.160	PUNTA HSS 16 MM SFUSA	5	171609	86
15.615	SET 13 PUNTE HSS 1,5/6,5MM	2	156156	85	201.1/4	FRESA ESTERNA 3/8-1"	1	201146	8
15.620	SET 13 PUNTE HSS 2/8MM	2	156200	85	201.6MA	FRESA ESTERNA 3/8-1"	1	201009	8
15.630	SET 9 PUNTE HSS-MURO	2	156309	85	202.1/4	FRESA ESTERNA INTERNA 3/8-1"	1	202143	8
15.640	SET 9 PUNTE HSS-MURO-LEGNO	2	156408	85	202.6MA	FRESA ESTERNA INTERNA 3/8-1"	1	202006	8
16.030	PUNTA WIDIA 3MM SFUSA	10	160306	87	203.6MA	FRESA ESTERNA 1/2-3/4	1	203003	8
16.040	PUNTA WIDIA 4MM SFUSA	10	160405	87	204.1/4	FRESA ESTERNA 1"1/8-2"	1	204147	8
16.050	PUNTA WIDIA 5MM SFUSA	10	160504	87	205.6MA	FRESA ESTERNA 3/8-1"	1	205007	8
16.055	PUNTA WIDIA 5,5MM SFUSA	10	160559	87	207.6MA	FRESA DOPPIO CONO + CONO 40	1	207001	8
16.060	PUNTA WIDIA 6MM SFUSA	10	160603	87	208.6MA	FRESA DOPPIO CONO GRANDE	1	208008	8
16.065	PUNTA WIDIA 6,5MM SFUSA	10	160658	87	209.6MA	FRESA DOPPIO CONO PICCOLA	1	209005	8
16.070	PUNTA WIDIA 7MM SFUSA	10	160702	87	210.6MA	FRESA CILINDRICA 3/8-1"	1	210001	9
16.080	PUNTA WIDIA 8MM SFUSA	10	160801	87	212.1/4	FRESA HOBBY ESTERNA 3/8-1/2	10	212142	8
16.090	PUNTA WIDIA 9MM SFUSA	10	160900	87	212.6MA	FRESA HOBBY ESTERNA 3/8-1/2	10	212005	8
16.100	PUNTA WIDIA 10MM SFUSA	10	161006	87	213.6MA	FRESA HOBBY CILINDRICA 3/8-1/2	10	213002	9
16.110	PUNTA WIDIA 11MM SFUSA	10	161105	87	214.00	FORALASTRA 20/123MM	5	214009	12
16.120	PUNTA WIDIA 12MM SFUSA	10	161204	87	214.10	UTENSILE HSS QUADRO 5 214.00	5	214108	12
16.130	PUNTA WIDIA 13MM SFUSA	10	161303	87	215.00	FORALASTRA 25/217MM	5	215006	12
16.140	PUNTA WIDIA 14MM SFUSA	10	161402	87	215.10	UTENSILE HSS QUADRO 6 215.00	5	215105	12
16.150	PUNTA WIDIA 15MM SFUSA	10	161501	87	216.00	FORALASTRA 27/104MM	5	216003	12
16.160	PUNTA WIDIA 16MM SFUSA	10	161600	87	216.10	UTENSILE HSS TONDO 5 216.00	5	216102	12
16.180	PUNTA WIDIA 18MM SFUSA	5	161808	87	217.00	TAGLIAPIASTRELLE CIRCOLARE	1	217000	72
16.200	PUNTA WIDIA 20MM SFUSA	5	162003	87	217.10	UTENSILE PER ART. 217.00	1	217109	72
16.408	PUNTA WIDIA 8X400MM	1	164083	87	218.00	GHIERA CONICA 14MA	10	218007	13
16.410	PUNTA WIDIA 10X400MM	1	164106	87	219.00	GHIERA PIANA 14MA	10	219004	13
16.412	PUNTA WIDIA 12X400MM	1	164120	87	220.00	GHIERA CONICA 8MA SFUSA	10	220000	13
16.414	PUNTA WIDIA 14X400MM	1	164144	87	220.50	GHIERA CONICA 10MA SFUSA COL16	10	220505	13
16.416	PUNTA WIDIA 16X400MM	1	164168	87	221.00	GHIERA CONICA 10MA SFUSA	10	221007	13
16.418	PUNTA WIDIA 18X400MM	1	164182	87	222.00	GHIERA CONICA 14MA SFUSA	10	222004	13
16.420	PUNTA WIDIA 20X400MM	1	164205	87	223.00	GHIERA CONICA 5/8 SFUSA	10	223001	13
16.422	PUNTA WIDIA 22X400MM	1	164229	87	224.00	GHIERA PIANA 8MA SFUSA	10	224008	13
16.425	PUNTA WIDIA 25X400MM	1	164250	87	225.00	GHIERA PIANA 10MA SFUSA	10	225005	13
16.610	PUNTA WIDIA 10X600MM	1	166100	87	226.00	GHIERA PIANA 14MA SFUSA	10	226002	13
16.612	PUNTA WIDIA 12X600MM	1	166124	87	227.00	GHIERA PIANA 5/8 SFUSA	10	227009	13
16.614	PUNTA WIDIA 14X600MM	1	166148	87	228.00	CHIAVE SERVIZIO GHIERE 35MM	10	228006	13
16.616	PUNTA WIDIA 16X600MM	1	166162	87	229.00	CHIAVE SERVIZIO GHIERE 35MM SF	10	229003	13
16.618	PUNTA WIDIA 18X600MM	1	166186	87	230.00	CHIAVE REGOLABILE GHIERE 20/35	10	230009	13
16.620	PUNTA WIDIA 20X600MM	1	166209	87	231.00	CHIAVE REGOLABILE GHIERE 20/35	10	231006	13
17.010	PUNTA HSS 1 MM SFUSA	10	170107	86	250.00	FLANGIA POST.POGGIA DISCO 115	1	250007	13
17.015	PUNTA HSS 1,5 MM SFUSA	10	170152	86	253.00	FLANGIA POST.POGGIA DISCO 230	1	253008	13
17.020	PUNTA HSS 2 MM SFUSA	10	170206	86	300.00	MORSETTO ALLARGATUBI 10/16MM	1	300009	9

INDICE NUMERICO: ARTICOLI, QUANTITÀ E CODICI A BARRE

Anteporre al codice EAN il prefisso 8011017

ref.	descrizione	☐	ean	pag.	ref.	descrizione	☐	ean	pag.
304.00	MORSETTO ALLARGATUBI 10/22MM	1	304007	9	341.00	15 DISCHI CARTA 125 GR. 80	10	341002	19
305.00	CHIAVE PER LAVABO	5	305004	10	342.00	15 DISCHI CARTA 125 GR.120	10	342009	19
316.00	TAGLIATUBO 16MM	5	316000	10	343.00	15 DISCHI CARTA 125 ASSORTITI	10	343006	19
328.00	TAGLIATUBO 28MM	5	328003	10	344.00	5 DISCHI CARTA 125 GR. 50	10	344003	19
332.00	TAGLIATUBO 32MM	5	332000	10	344.10	5 DISCHI CARTA 125 GR. 80	10	344102	19
332.35	TAGLIATUBO 35MM TELESCOPICO	5	332352	10	344.20	5 DISCHI CARTA 125 GR.120	10	344201	19
333.00	ROTELLA UNIVERSALE TAGLIATUBI	10	333007	10	344.30	5 DISCHI CARTA 125 ASSORTITI	10	344300	19
334.00	TAGLIATUBO 42MM TELESCOPICO	1	334004	10	345.10	DISCO TUNGSTENO 125 GR.MEDIA	10	345109	30
334.20	ROTELLA PER ART. 334.00	10	334202	10	345.20	DISCO TUNGSTENO 125 GR.FINE	10	345208	30
335.00	PERNO FISSAGGIO 10X6MM	10	335001	13	347.00	6 DISCHI FIBRA 115 GR. 36	10	347004	19
336.00	PERNO FISSAGGIO 12,8X8MM	10	336008	13	347.10	6 DISCHI FIBRA 115 GR. 60	10	347103	19
337.00	PERNO FISSAGGIO 22,2X8MM	10	337005	13	347.20	6 DISCHI FIBRA 115 GR.100	10	347202	19
338.00	PLATORELLO GOMMA 125MM	10	338002	14	348.00	6 DISCHI FIBRA 180 GR. 36	10	348001	19
338.05	PLATORELLO GOMMA 180MM	10	338057	14	348.10	6 DISCHI FIBRA 180 GR. 60	10	348100	19
338.08	PLATORELLO GOMMA 180MM SF	10	338088	14	348.20	6 DISCHI FIBRA 180 GR.100	10	348209	19
338.10	PLATORELLO NYLON 100X10MM	10	338101	14	348.25	10 FOGLI VELCRO GR. 60 339.79	5	348254	18
338.20	PLATORELLO NYLON 115X14MM	10	338200	14	348.26	10 FOGLI VELCRO GR.120 339.79	5	348261	18
338.22	PLATORELLO NYLON 178X14MM	10	338224	14	348.27	10 FOGLI VELCRO GR.240 339.79	5	348278	18
338.25	PLATORELLO NYLON 100X10MM SF	10	338255	14	348.30	5 FOGLI VELCRO FORATI GR. 40	10	348308	20
338.30	PLATORELLO NYLON 115X10MM SF	10	338309	14	348.31	25 FOGLI VELCRO FORATI GR. 40	1	348315	20
338.35	PLATORELLO NYLON 115X14MM SF	10	338354	14	348.35	5 FOGLI VELCRO FORATI GR. 60	10	348353	20
338.40	PLATORELLO NYLON 115X16MM SF	10	338408	14	348.36	25 FOGLI VELCRO FORATI GR. 60	1	348360	20
338.45	PLATORELLO NYLON 125X14MM SF	10	338453	14	348.40	5 FOGLI VELCRO FORATI GR. 80	10	348407	20
338.50	PLATORELLO NYLON 125X16MM SF	10	338507	14	348.41	25 FOGLI VELCRO FORATI GR. 80	1	348414	20
338.55	PLATORELLO NYLON 150X14MM SF	10	338552	14	348.45	5 FOGLI VELCRO FORATI GR.120	10	348452	20
338.60	PLATORELLO NYLON 150X16MM SF	10	338606	14	348.46	25 FOGLI VELCRO FORATI GR.120	1	348469	20
338.65	PLATORELLO NYLON 178X14MM SF	10	338651	14	348.50	5 FOGLI VELCRO FORATI GR.240	10	348506	20
338.70	PLATORELLO NYLON 178X16MM SF	10	338705	14	348.51	25 FOGLI VELCRO FORATI GR.240	1	348513	20
338.75	PLATORELLO NYLON 178X14 BIA.SF	10	338750	14	348.56	25 FOGLI VELCRO FORATI GR.ASS.	1	348568	20
338.80	PLATORELLO VELCRO 115MM M14	5	338804	14	349.00	10 DISCHI VELCRO 115 GR. 40	10	349008	20
338.82	PLATORELLO VELCRO 125MM M14	5	338828	14	349.01	25 DISCHI VELCRO 115 GR. 40	1	349015	20
338.85	PLATORELLO VELCRO 150MM M14	5	338859	14	349.10	10 DISCHI VELCRO 115 GR.120	10	349107	20
339.00	CUFFIA PER LUCIDARE 140MM	10	339009	15	349.11	25 DISCHI VELCRO 115 GR.120	1	349114	20
339.20	CUFFIA PER LUCIDARE 190MM	10	339207	15	349.20	10 DISCHI VELCRO 115 GR.240	10	349206	20
339.22	CUFFIA AGNELLO-VELCRO 115MM	10	339221	15	349.21	25 DISCHI VELCRO 115 GR.240	1	349213	20
339.23	CUFFIA AGNELLO-VELCRO 125MM	10	339238	15	349.30	10 DISCHI VELCRO 115 GR.ASS	10	349305	20
339.24	CUFFIA AGNELLO-VELCRO 160MM	10	339245	15	349.31	25 DISCHI VELCRO 115 GR.ASS	1	349312	20
339.25	DISCO FELTRO 80X10MM	10	339252	15	349.33	10 DISCHI VELCRO FO 115 GR. 40	10	349336	21
339.26	DISCO FELTRO 125MM VELCRO	10	339269	15	349.34	25 DISCHI VELCRO FO 115 GR. 40	1	349343	21
339.27	DISCO FELTRO 125X15MM	10	339276	15	349.35	10 DISCHI VELCRO FO 115 GR. 80	10	349350	21
339.28	DISCO FELTRO 150X20MM	10	339283	15	349.36	25 DISCHI VELCRO FO 115 GR. 80	1	349367	21
339.29	PANNO VELCRO LEVIG.DELTA 93MM	10	339290	15	349.40	10 DISCHI VELCRO FO 115 GR.120	10	349404	21
339.30	RUOTA IN TESSUTO 80MM	10	339306	15	349.41	25 DISCHI VELCRO FO 115 GR.120	1	349411	21
339.35	RUOTA IN TESSUTO 100MM	10	339351	15	349.45	10 DISCHI VELCRO FO 115 GR.240	10	349459	21
339.40	RUOTA IN TESSUTO 120MM	10	339405	15	349.46	25 DISCHI VELCRO FO 115 GR.240	1	349466	21
339.45	RUOTA IN TESSUTO 150MM	10	339450	15	349.50	10 DISCHI VELCRO FO 115 GR.ASS	10	349503	21
339.46	RUOTA IN SISAL E COTONE 80MM	10	339467	16	349.51	25 DISCHI VELCRO FO 115 GR.ASS	1	349510	21
339.49	RUOTA IN SISAL E COTONE 150MM	10	339498	16	349.55	10 DISCHI VELCRO 125 GR. 40	10	349558	20
339.50	TAMPONE PER LUCIDARE 125MM	1	339504	16	349.56	25 DISCHI VELCRO 125 GR. 40	1	349565	20
339.60	TAMPONE PER LUCIDARE 175MM M14	1	339603	16	349.60	10 DISCHI VELCRO 125 GR.120	10	349602	20
339.62	TAMPONE PER LUCIDARE 125MM	1	339627	16	349.61	25 DISCHI VELCRO 125 GR.120	1	349619	20
339.64	TAMPONE PER LUCIDARE 175MM	1	339641	16	349.65	10 DISCHI VELCRO 125 GR.240	10	349657	20
339.66	TAMPONE PER LUCIDARE VEL 115MM	1	339665	16	349.66	25 DISCHI VELCRO 125 GR.240	1	349664	20
339.67	TAMPONE PER LUCIDARE VEL 125MM	1	339672	16	349.70	10 DISCHI VELCRO 125 GR.ASS	10	349701	20
339.68	TAMPONE PER LUCIDARE VEL 160MM	1	339689	16	349.71	25 DISCHI VELCRO 125 GR.ASS	1	349718	20
339.70	TAMPONE GOMMA 125X70MM	10	339702	18	349.73	10 DISCHI VELCRO FO 125 GR. 40	10	349732	21
339.72	TAMPONE GOMMA 125X70MM VELCRO	5	339726	18	349.74	25 DISCHI VELCRO FO 125 GR. 40	1	349749	21
339.73	TAMPONE GOMMA VELCRO 125MM	5	339733	18	349.75	10 DISCHI VELCRO FO 125 GR. 80	10	349756	21
339.74	TAMPONE GOMMA VELCRO 125MM	5	339740	18	349.76	25 DISCHI VELCRO FO 125 GR. 80	1	349763	21
339.75	TAMPONE GOMMA VELCRO 125MM	5	339757	18	349.80	10 DISCHI VELCRO FO 125 GR.120	10	349800	21
339.76	TAMPONE GOMMA VELCRO 150MM	5	339764	18	349.81	25 DISCHI VELCRO FO 125 GR.120	1	349817	21
339.79	MINI-TAMPONE GOMMA VELCRO	5	339795	18	349.85	10 DISCHI VELCRO FO 125 GR.240	10	349855	21
339.80	SPUGNA ABRASIVA GR.60/100	10	339801	18	349.86	25 DISCHI VELCRO FO 125 GR.240	1	349862	21
339.81	250 SPUGNE ABRASIVE GR.60/100	1	339818	18	349.90	10 DISCHI VELCRO FO 125 GR.ASS	10	349909	21
339.85	24 SPUGNE ABRASIVE GR.60/100	1	339856	18	349.91	25 DISCHI VELCRO FO 125 GR.ASS	1	349916	21
339.90	2 SPUGNE ABRASIVE GR.100	10	339900	18	349.95	10 DISCHI VELCRO FO 150 GR. 40	10	349954	21
339.91	250 SPUGNE ABRASIVE GR.100	1	339917	18	349.96	10 DISCHI VELCRO FO 150 GR. 80	10	349961	21
340.00	15 DISCHI CARTA 125 GR. 50	10	340005	19	349.97	10 DISCHI VELCRO FO 150 GR.120	10	349978	21

INDICE NUMERICO: ARTICOLI, QUANTITÀ E CODICI A BARRE

Anteporre al codice EAN il prefisso 8011017

ref.	descrizione	☐	ean	pag.	ref.	descrizione	☐	ean	pag.
349.98	10 DISCHI VELCRO FO 150 GR.240	10	349985	21	355.90	ROTOLO CARTA 5M GR. 50	2	355900	24
349.99	10 DISCHI VELCRO FO 150 GR.ASS	10	349992	21	355.92	ROTOLO CARTA 5M GR. 80	2	355924	24
350.00	6 DISCHI TELA 125 GR. 40	10	350004	19	355.94	ROTOLO CARTA 5M GR.120	2	355948	24
351.00	6 DISCHI TELA 125 GR. 80	10	351001	19	355.96	ROTOLO CARTA VELCRO 3M GR. 50	2	355962	24
352.00	6 DISCHI TELA 125 GR.150	10	352008	19	355.97	ROTOLO CARTA VELCRO 3M GR. 80	2	355979	24
353.00	6 DISCHI TELA 125 ASSORTITI	10	353005	19	355.98	ROTOLO CARTA VELCRO 3M GR.120	2	355986	24
354.00	10 FOGLI VEL.FO 93X185 GR. 40	5	354002	25	356.00	10 FOGLI CARTA 93X230 GR. 50	10	356006	24
354.03	10 FOGLI VEL.FO 93X185 GR. 80	5	354033	25	356.01	25 FOGLI CARTA 93X230 GR. 50	1	356013	24
354.06	10 FOGLI VEL.FO 93X185 GR.120	5	354064	25	356.10	10 FOGLI CARTA 93X230 GR. 80	10	356105	24
354.09	10 FOGLI VEL.FO 93X185 GR.180	5	354095	25	356.11	25 FOGLI CARTA 93X230 GR. 80	1	356112	24
354.12	10 FOGLI VEL.FO 93X185 GR.ASS	5	354125	25	356.20	10 FOGLI CARTA 93X230 GR.120	10	356204	24
354.15	10 FOGLI VEL.FO 93X185 GR. 40	5	354156	25	356.21	25 FOGLI CARTA 93X230 GR.120	1	356211	24
354.18	10 FOGLI VEL.FO 93X185 GR. 80	5	354187	25	356.30	10 FOGLI CARTA 93X230 ASS.TI	10	356303	24
354.21	10 FOGLI VEL.FO 93X185 GR.120	5	354217	25	356.31	25 FOGLI CARTA 93X230 ASS.TI	1	356310	24
354.24	10 FOGLI VEL.FO 93X185 GR.180	5	354248	25	357.00	10 FOGLI CARTA 115X280 GR. 50	10	357003	24
354.27	10 FOGLI VEL.FO 93X185 GR.ASS	5	354279	25	357.01	25 FOGLI CARTA 115X280 GR. 50	1	357010	24
354.30	10 FOGLI FORATI 93X230 GR. 40	5	354309	25	357.10	10 FOGLI CARTA 115X280 GR. 80	10	357102	24
354.33	10 FOGLI FORATI 93X230 GR. 80	5	354330	25	357.11	25 FOGLI CARTA 115X280 GR. 80	1	357119	24
354.36	10 FOGLI FORATI 93X230 GR.120	5	354361	25	357.20	10 FOGLI CARTA 115X280 GR.120	10	357201	24
354.39	10 FOGLI FORATI 93X230 GR.180	5	354392	25	357.21	25 FOGLI CARTA 115X280 GR.120	1	357218	24
354.42	10 FOGLI FORATI 93X230 GR.ASS	5	354422	25	357.30	10 FOGLI CARTA 115X280 ASS.TI	10	357300	24
354.45	10 FOGLI FORATI 93X230 GR. 40	5	354453	26	357.31	25 FOGLI CARTA 115X280 ASS.TI	1	357317	24
354.48	10 FOGLI FORATI 93X230 GR. 80	5	354484	26	357.35	3 NASTRI ABRAS. 533X75 GR. 40	2	357355	28
354.51	10 FOGLI FORATI 93X230 GR.120	5	354514	26	357.36	3 NASTRI ABRAS. 533X75 GR. 60	2	357362	28
354.54	10 FOGLI FORATI 93X230 GR.180	5	354545	26	357.37	3 NASTRI ABRAS. 533X75 GR. 80	2	357379	28
354.57	10 FOGLI FORATI 93X230 GR.ASS	5	354576	26	357.38	3 NASTRI ABRAS. 533X75 GR.100	2	357386	28
354.60	10 FOGLI VEL.FO 115X230 GR. 40	5	354606	26	357.39	3 NASTRI ABRAS. 533X75 GR.150	2	357393	28
354.63	10 FOGLI VEL.FO 115X230 GR. 80	5	354637	26	357.40	3 NASTRI ABRAS. 410X65 GR. 40	3	357409	28
354.66	10 FOGLI VEL.FO 115X230 GR.120	5	354668	26	357.45	3 NASTRI ABRAS. 410X65 GR. 60	3	357454	28
354.69	10 FOGLI VEL.FO 115X230 GR.180	5	354699	26	357.50	3 NASTRI ABRAS. 410X65 GR. 80	3	357508	28
354.72	10 FOGLI VEL.FO 115X230 GR.ASS	5	354729	26	357.55	3 NASTRI ABRAS. 410X65 GR.100	3	357553	28
354.75	10 FOGLI FORATI 115X280 GR. 40	5	354750	26	357.57	3 NASTRI ABRAS. 410X65 GR.150	3	357577	28
354.78	10 FOGLI FORATI 115X280 GR. 80	5	354781	26	357.60	3 NASTRI ABRAS. 510X75 GR. 40	2	357607	28
354.81	10 FOGLI FORATI 115X280 GR.120	5	354811	26	357.65	3 NASTRI ABRAS. 510X75 GR. 60	2	357652	28
354.84	10 FOGLI FORATI 115X280 GR.180	5	354842	26	357.70	3 NASTRI ABRAS. 510X75 GR. 80	2	357706	28
354.87	10 FOGLI FORATI 115X280 GR.ASS	5	354873	26	357.75	3 NASTRI ABRAS. 510X75 GR.100	2	357751	28
355.10	3 NASTRI ABRAS. 400X60 GR. 40	3	355108	27	357.77	3 NASTRI ABRAS. 510X75 GR.150	2	357775	28
355.11	3 NASTRI ABRAS. 400X60 GR. 60	3	355115	27	357.78	3 NASTRI ABRAS. 457X75 GR. 40	2	357782	28
355.12	3 NASTRI ABRAS. 400X60 GR. 80	3	355122	27	357.79	3 NASTRI ABRAS. 457X75 GR. 60	2	357799	28
355.13	3 NASTRI ABRAS. 400X60 GR.100	3	355139	27	357.80	3 NASTRI ABRAS. 457X75 GR. 80	2	357805	28
355.14	3 NASTRI ABRAS. 400X60 GR.150	3	355146	27	357.81	3 NASTRI ABRAS. 457X75 GR.100	2	357812	28
355.15	3 NASTRI ABRAS. 560X100 GR. 40	2	355153	27	357.82	3 NASTRI ABRAS. 457X75 GR.150	2	357829	28
355.16	3 NASTRI ABRAS. 560X100 GR. 60	2	355160	27	357.96	SMERIGLIATORE ESPANSIONE 45X30	10	357966	29
355.17	3 NASTRI ABRAS. 560X100 GR. 80	2	355177	27	357.98	3 NASTRI PER SMERIGLIATORE	10	357980	29
355.18	3 NASTRI ABRAS. 560X100 GR.100	2	355184	27	358.00	DISCO LAMELLARE 115 NYLON 80	10	358000	30
355.19	3 NASTRI ABRAS. 560X100 GR.150	2	355191	27	358.05	DISCO LAMELLARE 180 NYLON 80	10	358055	30
355.20	3 NASTRI ABRAS. 610X100 GR. 40	2	355207	27	358.10	DISCO LAMELLARE 115 NYLON 40	10	358109	30
355.21	3 NASTRI ABRAS. 610X100 GR. 60	2	355214	27	358.15	DISCO LAMELLARE 115 NYLON 80	10	358154	30
355.22	3 NASTRI ABRAS. 610X100 GR. 80	2	355221	27	358.20	DISCO LAMELLARE 115 NYLON 120	10	358208	30
355.23	3 NASTRI ABRAS. 610X100 GR.100	2	355238	27	358.25	DISCO LAMELLARE 180 NYLON 40	10	358253	30
355.24	3 NASTRI ABRAS. 610X100 GR.150	2	355245	27	358.30	DISCO LAMELLARE 180 NYLON 80	10	358307	30
355.25	3 NASTRI ABRAS. 620X100 GR. 40	2	355252	27	358.35	DISCO LAMELLARE 180 NYLON 120	10	358352	30
355.26	3 NASTRI ABRAS. 620X100 GR. 60	2	355269	27	358.40	RUOTA LAMELLARE 40X20 GR. 80	10	358406	29
355.27	3 NASTRI ABRAS. 620X100 GR. 80	2	355276	27	358.50	RUOTA LAMELLARE 50X20 GR. 80	10	358505	29
355.28	3 NASTRI ABRAS. 620X100 GR.100	2	355283	27	358.60	RUOTA LAMELLARE 60X40 GR. 80	10	358604	29
355.29	3 NASTRI ABRAS. 620X100 GR.150	2	355290	27	358.80	RUOTA LAMELLARE 80X30 GR. 80	10	358802	29
355.60	6 FOGLI CARTA 230X280 GR. 60	10	355603	22	358.90	ASSORTIMENTO 40 RUOTE LAM.RI	1	358901	29
355.62	6 FOGLI CARTA 230X280 GR.100	10	355627	22	359.00	DISCO LAMELLARE 115 FIBRA 80	10	359007	30
355.64	6 FOGLI CARTA 230X280 GR.150	10	355641	22	359.05	DISCO LAMELLARE 180 FIBRA 80	10	359052	30
355.66	6 FOGLI CARTA 230X280 ASS.TI	10	355665	22	359.10	DISCO LAMELLARE 115 FIBRA 40	10	359106	30
355.70	6 FOGLI CARTA IMPERM.LE GR.180	10	355702	22	359.15	DISCO LAMELLARE 115 FIBRA 80	10	359151	30
355.72	6 FOGLI CARTA IMPERM.LE GR.320	10	355726	22	359.20	DISCO LAMELLARE 115 FIBRA 120	10	359205	30
355.74	6 FOGLI CARTA IMPERM.LE GR.600	10	355740	22	359.25	DISCO LAMELLARE 180 FIBRA 40	10	359250	30
355.76	6 FOGLI CARTA IMPERM.LE ASS.TI	10	355764	22	359.30	DISCO LAMELLARE 180 FIBRA 80	10	359304	30
355.80	6 FOGLI TELA 230X280 GR. 60	10	355801	23	359.35	DISCO LAMELLARE 180 FIBRA 120	10	359359	30
355.82	6 FOGLI TELA 230X280 GR.120	10	355825	23	359.36	2 STICK PASTA PRE-LUCIDATURA	10	359366	16
355.84	6 FOGLI TELA 230X280 GR.240	10	355849	23	359.37	2 STICK PASTA LUCIDATURA	10	359373	16
355.86	6 FOGLI TELA 230X280 ASS.TI	10	355863	23	359.38	2 STICK PASTA ASSORTITI	10	359380	16

INDICE NUMERICO: ARTICOLI, QUANTITÀ E CODICI A BARRE

Anteporre al codice EAN il prefisso 8011017

ref.	descrizione	📦	ean	pag.	ref.	descrizione	📦	ean	pag.
359.40	RUOTA PANNI ABRASIVO 50X25MM	5	359403	17	397.30	SET 48 MOLE/GAMBO 3MM ASS.TE	1	397306	31
359.42	RUOTA PANNI ABRASIVO 75X45MM	5	359427	17	397.60	SET 3 MOLE/GAMBO 3MM AF.CATENE	10	397603	31
359.44	RUOTA PANNI ABRASIVO 100X50MM	5	359441	17	398.00	SET 5 MOLE/GAMBO 3MM	10	398006	31
359.46	RUOTA PANNI-TELA ABR. 50X25MM	5	359465	17	399.00	SET 5 MOLE/GAMBO 6MM	10	399003	31
359.48	RUOTA PANNI-TELA ABR. 75X45MM	5	359489	17	400.00	MOLA ABRASIVA 75X10X10MM A96	10	400006	34
359.50	RUOTA PANNI-TELA ABR.100X50MM	5	359502	17	402.00	MOLA ABRASIVA 75X10X13MM A96	10	402000	34
359.70	RUOTA PANNI ABRASIVO 150X25MM	5	359700	17	403.00	MOLA ABRASIVA 75X10X13MM C49	10	403007	34
359.72	RUOTA PANNI-TELA ABR.150X25MM	5	359724	17	404.00	MOLA ABRASIVA 100X12X13MM A96	10	404004	34
359.82	DISCO IN FIBRE DI NYLON 100MM	5	359823	17	404.50	MOLA ABRASIVA 125X15X16MM A96	10	404509	34
359.86	DISCO IN FIBRE DI NYLON 115MM	5	359861	17	405.00	MOLA ABRASIVA 150X20X16MM A96	10	405001	34
360.00	FRESA MEZZO TONDA 45° 35MM	5	360003	39	406.00	MOLA FERRO 125X2,5X13MM	10	406008	34
361.00	FRESA MEZZO TONDA 45° 35MM	5	361000	39	406.95	MOLA FERRO 115X1,0X22MM SFUSA	10	406954	34
362.00	FRESA PROFILO CONCAVO 35MM	5	362007	39	407.00	MOLA FERRO 115X1,6X22MM	10	407005	34
363.00	FRESA PROFILO CONVESSO 35MM	5	363004	39	407.05	MOLA FERRO 115X1,6X22MM SFUSA	10	407050	34
364.00	FRESA CILINDRICA 25MM	5	364001	39	408.00	MOLA MARMO 125X2,5X13MM	10	408002	34
364.50	FRESA PROFILO TONDO 25MM	5	364506	39	409.00	MOLA MARMO 115X1,6X22MM	10	409009	34
365.00	FRESA CONICA 45° 35MM	5	365008	39	409.05	MOLA MARMO 115X1,6X22MM SFUSA	10	409054	34
366.00	FRESA SCANALARE 35MM	5	366005	39	413.00	MOLA FERRO 115X3,2X22MM	10	413006	35
367.00	FRESA DOPPIA BATTUTA 30MM	5	367002	39	413.05	MOLA FERRO 115X3,2X22MM SFUSA	10	413051	35
368.00	FRESA INTAGLI 30X1,5MM	5	368009	39	413.50	MOLA MARMO 115X3,2X22MM	10	413501	35
369.00	FRESA INTAGLI 30X2,5MM	5	369006	39	413.55	MOLA MARMO 115X3,2X22MM SFUSA	10	413556	35
370.00	FRESA A SEGA 45MM	5	370002	39	414.00	MOLA FERRO 115X6,4X22MM	10	414003	35
372.00	FRESA A DITO 6MM PER MORTASARE	5	372006	39	414.05	MOLA FERRO 115X6,4X22MM SFUSA	10	414058	35
373.00	FRESATRICE UNIVERSALE	1	373003	39	414.50	MOLA MARMO 115X6,4X22MM	10	414508	35
374.03	PUNTA-FRESA REGOLABILE 3MM	10	374031	39	414.55	MOLA MARMO 115X6,4X22MM SFUSA	10	414553	35
374.04	PUNTA-FRESA REGOLABILE 4MM	10	374048	39	418.00	MOLA FERRO 230X3,2X22MM SFUSA	25	418001	35
374.05	PUNTA-FRESA REGOLABILE 5MM	10	374055	39	418.10	MOLA MARMO 230X3,2X22MM SFUSA	25	418100	35
374.06	PUNTA-FRESA REGOLABILE 6MM	10	374062	39	419.60	DISCO DIAMANTATO TURBO 115MM	1	419602	38
375.00	FRESA SVASARE 6MM	10	375007	40	419.65	DISCO DIAMANTATO TURBO 230MM	1	419657	38
376.00	FRESA SVASARE 12MM	10	376004	40	419.70	DISCO DIAMANTATO SEGM.TO 115MM	1	419701	38
377.00	FRESA SVASARE 16MM	10	377001	40	419.75	DISCO DIAMANTATO SEGM.TO 230MM	1	419756	38
378.00	FRESA SVASARE 19MM	10	378008	40	419.80	DISCO DIAMANTATO COR.CON.115MM	1	419800	38
379.00	FRESA SVASARE 13MM A OMBRELLO	10	379005	40	419.85	DISCO DIAMANTATO COR.CON.230MM	1	419855	38
379.50	FRESA CERNIERA 20MM	10	379500	40	419.90	DISCO PER LEGNO 115MM	5	419909	38
380.00	FRESA CERNIERA 26MM	10	380001	40	419.95	DISCO PER LEGNO 230MM	1	419954	38
381.00	FRESA CERNIERA 30MM	10	381008	40	420.00	LIMA ROTATIVA CILINDRICA	10	420004	43
382.00	FRESA CERNIERA 35MM	10	382005	40	422.00	LIMA ROTATIVA CONICA	10	422008	43
383.00	FRESA CERNIERA 38MM	10	383002	40	424.00	LIMA ROTATIVA CILINDR.BOMBATA	10	424002	43
384.00	FRESA CERNIERA MET.DURO 26MM	5	384009	40	426.00	LIMA ROTATIVA SFERICA	10	426006	43
384.10	FRESA CERNIERA MET.DURO 30MM	5	384108	40	43.034	COLLARE RIDUZIONE 43X34MM	1	430348	84
384.20	FRESA CERNIERA MET.DURO 35MM	5	384207	40	43.037	COLLARE RIDUZIONE 43X37MM	1	430379	84
384.50	MECCHIA PER LEGNO 6MM	10	384504	41	43.038	COLLARE RIDUZIONE 43X38MM	1	430386	84
385.00	MECCHIA PER LEGNO 8MM	10	385006	41	43.384	COLLARE RIDUZIONE 43X38,4MM	1	433844	84
386.00	MECCHIA PER LEGNO 10MM	10	386003	41	430.00	RASPA ROTATIVA CILINDRICA	10	430003	43
387.00	MECCHIA PER LEGNO 12MM	10	387000	41	432.00	RASPA ROTATIVA CONICA	10	432007	43
388.00	MECCHIA PER LEGNO 14MM	10	388007	41	434.00	RASPA ROTATIVA SFERICA	10	434001	43
389.00	MECCHIA PER LEGNO 16MM	10	389004	41	436.00	RASPA ROTATIVA CONICA BOMBATA	10	436005	43
390.00	MECCHIA PER LEGNO 18MM	10	390000	41	438.00	FRESA ROTATIVA A SVASARE	10	438009	43
391.00	MECCHIA PER LEGNO 20MM	10	391007	41	440.00	PUNTA-RASPA 6X90MM	10	440002	43
392.00	MECCHIA PER LEGNO 22MM	10	392004	41	440.20	RASPA ROTAT.CONICA ATT.ESAG.LE	5	440200	43
392.50	MECCHIA PER LEGNO 24MM	10	392509	41	440.40	RASPA ROT.CIL.BOMB.ATT.ESAG.LE	5	440408	43
393.00	MECCHIA PER LEGNO 25MM	10	393001	41	445.00	PUNTA-FRESA 6X85MM	10	445007	43
393.20	MECCHIA PER LEGNO 26MM	10	393209	41	445.20	LIMA ROTAT.CONICA ATT.ESAG.LE	5	445205	43
393.40	MECCHIA PER LEGNO 28MM	10	393407	41	445.30	LIMA ROT.CIL.BOMB. ATT.ESAG.LE	5	445304	43
393.60	MECCHIA PER LEGNO 30MM	10	393605	41	446.00	SET 3 MINI FRESE-RASPE	10	446004	43
394.00	MECCHIA PER LEGNO 32MM	10	394008	41	447.00	SET 6 FRESE-RASPE	5	447001	43
394.20	MECCHIA PER LEGNO 35MM	10	394206	41	448.00	FRESA-RASPA 10/15MM	10	448008	44
394.40	MECCHIA PER LEGNO 38MM	10	394404	41	448.10	FRESA-RASPA 15/20MM	10	448107	44
394.70	MECCHIA REGOLABILE 15/45MM	2	394701	41	448.20	FRESA-RASPA 20/25MM	10	448206	44
394.80	MECCHIA REGOLABILE 22/76MM	2	394800	41	449.06	LIMA-RASPA PIATTA 150MM - 6"	10	449067	44
394.84	PROLUNGA PER MECCHIE 150MM	5	394848	41	449.08	LIMA-RASPA PIATTA 200MM - 8"	10	449081	44
394.86	PROLUNGA PER MECCHIE 300MM	5	394862	41	449.20	SET 6 LIME ASSORTITE 100MM	5	449203	44
395.00	MOLA PER AFFILARE	10	395005	31	449.40	2 LIME PER SEGHE CATENA 4,0MM	10	449401	44
395.20	COTE PER AFFILARE	10	395203	31	449.45	12 LIME PER SEGHE CATENA 4,0MM	2	449456	44
395.40	COTE PER AFFILARE SF	10	395401	31	449.50	2 LIME PER SEGHE CATENA 4,8MM	10	449500	44
396.00	SET 100 MOLE/GAMBO 6MM	1	396002	31	449.55	12 LIME PER SEGHE CATENA 4,8MM	2	449555	44
397.00	SET 45 MOLE/GAMBO 3/6MM	1	397009	31	449.60	2 LIME PER SEGHE CATENA 5,6MM	10	449609	44
397.20	SET 48 MOLE/GAMBO 3MM CILIND.	1	397207	31	449.65	12 LIME PER SEGHE CATENA 5,6MM	2	449654	44

INDICE NUMERICO: ARTICOLI, QUANTITÀ E CODICI A BARRE

Anteporre al codice EAN il prefisso 8011017

ref.	descrizione	☐	ean	pag.	ref.	descrizione	☐	ean	pag.
451.00	FRESA MANUALE A SVASARE	10	451008	40	468.01	20 SPAZZOLE CIR.CONICHE 120MM	1	468013	48
451.10	FRESA SVASARE ATT.ESAG.LE 10MM	5	451107	40	468.20	SPAZZOLA CIRC.CONICA 150MM M14	5	468204	48
451.20	FRESA SVASARE ATT.ESAG.LE 13MM	5	451206	40	468.30	SPAZZOLA CIRC.CONICA 100MM RIT	5	468303	48
451.30	FRESA SVASARE ATT.ESAG.LE 16MM	5	451305	40	468.35	SPAZZOLA CIRC.CONICA 120MM RIT	5	468358	48
452.00	PORTA INSERTI MAGNETICO	10	452005	45	468.40	SPAZZOLA CIRC.CONICA 150MM RIT	5	468402	48
452.05	PORTA INSERTI RIL. RAPIDO 60MM	5	452050	45	468.50	SPAZZOLA CIRCOLARE 40MM	10	468501	49
452.10	PORTA INSERTI ARRESTO PROF.TA'	5	452104	45	468.51	20 SPAZZOLE CIRCOLARI 40MM	1	468518	49
452.15	PORTA INSERTI FLESSIBILE 190MM	5	452159	45	469.00	SPAZZOLA CIRCOLARE 50MM	10	469003	49
452.20	PORTA INSERTI ATTACCO SDS	5	452203	45	469.01	20 SPAZZOLE CIRCOLARI 50MM	1	469010	49
452.30	AVVITATORE A SQUADRA 90°	5	452302	45	470.00	SPAZZOLA CIRCOLARE 75MM	10	470009	49
452.40	2 INSERTI TORX 10	10	452401	45	470.01	20 SPAZZOLE CIRCOLARI 75MM	1	470016	49
452.50	2 INSERTI TORX 15	10	452500	45	470.50	SPAZZOLA CIRCOLARE 75MM D.SP.	10	470504	49
452.60	2 INSERTI TORX 20	10	452609	45	475.00	SPAZZOLA CIRCOLARE 100MM	10	475004	49
452.70	2 INSERTI TORX 25	10	452708	45	475.01	20 SPAZZOLE CIRCOLARI 100MM	1	475011	49
452.80	2 INSERTI TORX 30	10	452807	45	475.50	SPAZZOLA CIRCOLARE 100MM D.SP.	10	475509	49
452.90	2 INSERTI TORX 40	10	452906	45	475.65	SPAZZOLA CIRCOLARE 75MM M.RIT	5	475653	49
452.92	2 INSERTI TORX 10 TITANIO	5	452920	45	475.70	SPAZZOLA CIRCOLARE 100MM M.RIT	5	475707	49
452.93	2 INSERTI TORX 15 TITANIO	5	452937	45	476.00	3 MINI SPAZZOLE ASSORTITE	10	476001	50
452.94	2 INSERTI TORX 20 TITANIO	5	452944	45	477.00	SPAZZOLA PENNELLO 16MM	10	477008	50
452.95	2 INSERTI TORX 25 TITANIO	5	452951	45	477.01	20 SPAZZOLE PENNELLO 16MM	1	477015	50
452.96	2 INSERTI TORX 30 TITANIO	5	452968	45	478.00	SPAZZOLA PENNELLO 25MM	10	478005	50
452.97	2 INSERTI TORX 40 TITANIO	5	452975	45	478.01	20 SPAZZOLE PENNELLO 25MM	1	478012	50
453.00	2 INSERTI CAVA ESAG.LE 2MM	10	453002	46	478.20	SPAZZOLA FUNGO 30MM	10	478203	50
453.10	2 INSERTI CAVA ESAG.LE 2,5MM	10	453101	46	478.40	SPAZZOLA FUNGO 40MM	10	478401	50
453.20	2 INSERTI CAVA ESAG.LE 3MM	10	453200	46	479.00	SPAZZOLA SCOVOLO 28MM	10	479002	50
453.30	2 INSERTI CAVA ESAG.LE 4MM	10	453309	46	479.01	20 SPAZZOLE SCOVOLO 28MM	1	479019	50
453.40	2 INSERTI CAVA ESAG.LE 5MM	10	453408	46	480.00	SPAZZOLA TAZZA 50MM	10	480008	51
453.50	2 INSERTI CAVA ESAG.LE 6MM	10	453507	46	480.01	20 SPAZZOLE TAZZA 50MM	1	480015	51
454.00	2 INSERTI PHILLIPS N.1	10	454009	46	485.00	SPAZZOLA TAZZA 70MM	10	485003	51
455.00	2 INSERTI PHILLIPS N.2	10	455006	46	485.01	20 SPAZZOLE TAZZA 70MM	1	485010	51
456.00	2 INSERTI PHILLIPS N.3	10	456003	46	485.20	SPAZZOLA TAZZA 85MM	10	485201	51
456.20	INSERTO PHILLIPS N.4	10	456201	46	485.21	20 SPAZZOLE TAZZA 85MM	1	485218	51
456.50	2 INSERTI PHILIPS 1 TITANIO	5	456508	46	485.30	SPAZZOLA TAZZA 60MM M14	10	485300	51
456.52	2 INSERTI PHILIPS 2 TITANIO	5	456522	46	485.31	20 SPAZZOLE TAZZA 60MM M14	1	485317	51
456.54	2 INSERTI PHILIPS 3 TITANIO	5	456546	46	485.40	SPAZZOLA TAZZA 85MM M14	10	485409	51
457.00	2 INSERTI TAGLIO 0,8X4MM	10	457000	46	485.41	20 SPAZZOLE TAZZA 85MM M14	1	485416	51
458.00	2 INSERTI TAGLIO 0,8X5MM	10	458007	46	485.50	SPAZZOLA TAZZA 100MM M14	5	485508	51
459.00	2 INSERTI TAGLIO 1,0X6MM	10	459004	46	485.51	10 SPAZZOLE TAZZA 100MM M14	1	485515	51
459.20	2 INSERTI TAGLIO 1,2X7,2MM	10	459202	46	485.60	SPAZZOLA TAZZA 120MM M14	5	485607	51
459.40	2 INSERTI TAGLIO 1,6X8MM	10	459400	46	485.61	5 SPAZZOLE TAZZA 120MM M14	1	485614	51
459.50	2 INSERTI TAGLIO 0,8X4 TITANIO	5	459509	46	485.65	SPAZZOLA TAZZA 150MM M14	5	485652	51
459.52	2 INSERTI TAGLIO 0,8X5 TITANIO	5	459523	46	485.70	SPAZZOLA TAZZA 65MM M14 M.RIT	5	485706	51
459.54	2 INSERTI TAGLIO 1,0X6 TITANIO	5	459547	46	485.75	SPAZZOLA TAZZA 85MM M14 M.RIT	5	485751	51
459.90	2 INSERTI POZIDRIV N.0	10	459905	47	485.76	SPAZZOLA TAZZA 100MM M14 M.RIT	1	485768	51
460.00	2 INSERTI POZIDRIV N.1	10	460000	47	485.77	SPAZZOLA TAZZA 120MM M14 M.RIT	1	485775	51
460.10	2 INSERTI POZIDRIV N.2	10	460109	47	485.80	SPAZZOLA CIRCOLARE 75X13MM	10	485805	49
460.20	2 INSERTI POZIDRIV N.3	10	460208	47	486.00	SPAZZOLA CIRCOLARE 100X13MM	10	486000	49
460.30	INSERTO POZIDRIV N.4	10	460307	47	487.00	SPAZZOLA CIRCOLARE 120X16MM	10	487007	49
460.50	2 INSERTI POZIDRIV N.0 TITANIO	5	460505	47	488.00	SPAZZOLA CIRCOLARE 150X16MM	10	488004	49
460.52	2 INSERTI POZIDRIV N.1 TITANIO	5	460529	47	489.00	SPAZZOLA CIRC.RE 200X20X20MM	1	489001	49
460.54	2 INSERTI POZIDRIV N.2 TITANIO	5	460543	47	489.50	SPAZZOLA CIRC.RE 200X40X20MM	3	489506	49
460.56	2 INSERTI POZIDRIV N.3 TITANIO	5	460567	47	490.00	SPAZZOLA OTTONE CIRC.RE 75MM	10	490007	48
461.00	INSERTO 0,8X4 + PHILLIPS N.1	10	461007	47	495.00	SPAZZOLA OTTONE TAZZA 50MM	10	495002	48
462.00	INSERTO 0,8X5 + PHILLIPS N.2	10	462004	47	496.00	ASSORTIMENTO 40 SPAZZOLE	1	496009	53
462.50	INSERTO 1,2X7,2 + PHILLIPS N.3	10	462509	47	496.50	ASSORTIMENTO 30 SPAZZOLE NYLON	1	496504	53
463.00	KIT 7 INSERTI ASSORTITI	5	463001	47	496.82	SPAZZOLA A MANO MINI - ACCIAIO	12	496825	53
463.50	KIT 7 INSERTI ASSORTITI TORX	5	463506	47	496.85	SPAZZOLA A MANO MINI - OTTONE	12	009612	53
464.00	KIT 10 INSERTI ASSORTITI	5	464008	47	496.88	SPAZZOLA A MANO MINI - NYLON	12	496887	53
PG32A	KIT 32 INSERTI ASSORTITI	1	071046	47	497.00	SPAZZOLA A MANO UNIVERSALE	24	497006	54
465.02	PUNTA HSS ATT.ESAGONALE 2MM	10	465029	86	497.02	KIT 5 SPAZZOLE IN ACCIAIO	3	497020	54
465.03	PUNTA HSS ATT.ESAGONALE 3MM	10	465036	86	497.04	KIT 4 SPAZZOLE IN ACCIAIO	10	497044	54
465.04	PUNTA HSS ATT.ESAGONALE 4MM	10	465043	86	497.05	SPAZZOLA NYLON CIRC. 75 GR. 80	5	497051	52
465.05	PUNTA HSS ATT.ESAGONALE 5MM	10	465050	86	497.10	SPAZZOLA NYLON CIRC. 75 GR.150	5	497105	52
466.00	SPAZZOLA CIRC.CONICA 90MM	10	466002	48	497.15	SPAZZOLA NYLON CIRC.100 GR. 80	5	497150	52
466.01	20 SPAZZOLE CIR.CONICHE 90MM	1	466019	48	497.20	SPAZZOLA NYLON CIRC.100 GR.150	5	497204	52
467.00	SPAZZOLA CIRC.CONICA 90MM M14	10	467009	48	497.25	SPAZZOLA NYLON TAZZA 50 GR. 80	5	497259	52
467.01	20 SPAZZOLE CIR.CONICHE 90MM	1	467016	48	497.30	SPAZZOLA NYLON TAZZA 50 GR.150	5	497303	52
468.00	SPAZZOLA CIRC.CONICA 120MM M14	10	468006	48	497.35	SPAZZOLA NYLON TAZZA 70 GR. 80	5	497358	52

INDICE NUMERICO: ARTICOLI, QUANTITÀ E CODICI A BARRE

Anteporre al codice EAN il prefisso 8011017

ref.	descrizione	☐	ean	pag.	ref.	descrizione	☐	ean	pag.
497.40	SPAZZOLA NYLON TAZZA 70 GR.150	5	497402	52	566.00	COLTELLO ANTINFORTUNISTICA	4	566009	61
497.45	SPAZZOLA NYLON PEN. 25 GR. 80	5	497457	52	566.05	COLTELLO PROF.LE + 5 LAME	4	566054	61
497.50	SPAZZOLA NYLON PEN. 25 GR.150	5	497501	52	566.11	CUTTER AUTOMATICO + 5 LAME	2	566115	61
497.55	SPAZZOLA NYLON VENT.100 GR. 80	5	497556	52	566.12	CUTTER LAMA 25MM GUIDA METALLO	12	566122	61
497.60	SPAZZOLA NYLON VENT.100 GR.150	5	497600	52	566.14	CUTTER LAMA 9MM G.META.3 LAME	24	566146	61
498.00	OCCHIALI SALDATURA CE	5	498003	56	566.16	CUTTER LAMA 18MM G.META.3 LAME	24	566160	61
498.50	OCCHIALI SALDATURA D.LENTE CE	5	498508	56	566.17	CUTTER LAMA 9MM AUTO + 3 LAME	12	566177	61
498.60	OCCHIALI SALDATURA D.LENTE CE	1	498607	56	566.18	CUTTER LAMA 18MM AUTO + 3 LAME	12	566184	61
50.010	SUPPORTO PER TRAPANI 43MM	1	500102	84	566.20	CUTTER LAMA 9MM CORPO METALLO	24	566207	61
50.020	SUPPORTO PER TRAPANI 43MM	1	500201	84	566.23	CUTTER LAMA 9MM CORPO ABS	24	566238	61
50.030	SUPPORTO PER TRAPANI 60MM	1	500300	84	566.25	CUTTER LAMA 9MM GUIDA METALLO	24	566252	61
50.040	SUPPORTO PER TRAPANI 60MM	1	500409	84	566.30	CUTTER LAMA 9MM CORPO ABS TR.	24	566306	62
50.060	SUPPORTO SMERIGLIATRICE 230MM	1	500607	83	566.40	CUTTER LAMA 18MM CORPO ABS TR.	24	566405	62
50.070	SUPPORTO SMERIGLIATRICE 230MM	1	500706	83	566.50	CUTTER LAMA 18MM GUIDA METALLO	24	566504	62
50.080	SUPPORTO SMERIGLIATRICE 230MM	1	500805	83	566.60	CUTTER LAMA 18MM GUIDA METALLO	24	566603	62
50.090	SUPPORTO SMERIGLIATRICE 115MM	1	500904	83	567.00	RASCHIETTO CON LAMA RETRAIBILE	24	567006	62
500.00	OCCHIALI PROTEZIONE CE	1	500003	56	568.00	5 LAME A TRAPEZIO PICCOLO	12	568003	62
500.25	OCCHIALI PROTEZIONE CE	1	500256	56	568.10	5 LAME A TRAPEZIO GRANDE	12	568102	62
500.35	OCCHIALI PROTEZIONE CE	1	500355	56	568.20	5 LAME AD UNCINO	12	568201	62
501.00	OCCHIALI PROTEZIONE	5	501000	56	568.30	10 LAME PER CUTTER 9MM	12	568300	62
501.20	OCCHIALI PROTEZIONE CE	1	501208	56	568.40	10 LAME PER CUTTER 18MM	12	568409	62
501.40	OCCHIALI PROTEZIONE CE	1	501406	56	568.50	5 LAME PER CUTTER 25MM	12	568508	62
501.60	OCCHIALI PROTEZIONE CE	1	501604	56	569.00	TAGLIAVETRO	5	569000	62
502.00	5 MASCHERE PROTETTIVE	10	502007	57	570.00	SET 5 SGORBIE PER LEGNO	2	570006	63
502.50	50 MASCHERE PROTETTIVE	1	502502	57	572.00	SET 6 SGORBIE PER LEGNO	2	572000	63
502.60	2 MASCHERE PROTETTIVE CE	10	502601	57	575.00	SCALPELLO PER FALEGNAME 6MM	5	575001	63
502.70	2 MASCHERE PROTETTIVE CE	5	502700	57	576.00	SCALPELLO PER FALEGNAME 8MM	5	576008	63
503.00	MASCHERA PROTETTIVA RINFORZATA	10	503004	57	577.00	SCALPELLO PER FALEGNAME 10MM	5	577005	63
504.00	RESPIRATORE + FILTRO ANTIPOLV.	5	504001	57	578.00	SCALPELLO PER FALEGNAME 12MM	5	578002	63
504.20	FILTRO ANTIPOLVERE	5	504209	57	579.00	SCALPELLO PER FALEGNAME 14MM	5	579009	63
504.40	FILTRO CHIMICO	5	504407	57	580.00	SCALPELLO PER FALEGNAME 16MM	5	580005	63
504.50	RESPIRATORE + 1 FILTRO A1 CE	1	504506	57	581.00	SCALPELLO PER FALEGNAME 18MM	5	581002	63
504.55	FILTRO A1 PER RESP.RE 504.50	2	504551	57	582.00	SCALPELLO PER FALEGNAME 20MM	5	582009	63
504.58	FILTRO P3 PER RESP.RE 504.50	2	504582	57	583.00	SCALPELLO PER FALEGNAME 26MM	5	583006	63
504.70	RESPIRATORE + 2 FILTRI A1 CE	1	504704	58	584.00	SCALPELLO PER FALEGNAME 30MM	5	584003	63
504.75	FILTRO A1 PER RESP.RE 504.70	2	504759	58	585.00	SCALPELLO PER FALEGNAME 32MM	5	585000	63
504.78	FILTRO P3 PER RESP.RE 504.70	2	504780	58	586.00	SCALPELLO PER FALEGNAME 40MM	5	586007	63
505.00	CUFFIA ANTIRUMORE	5	505008	58	590.00	TRIVELLINO PER LEGNO 2MM	10	590004	63
505.20	CUFFIA ANTIRUMORE CE	1	505206	58	591.00	TRIVELLINO PER LEGNO 3MM	10	591001	63
505.40	CUFFIA ANTIRUMORE PROF.LE CE	1	505404	58	592.00	TRIVELLINO PER LEGNO 4MM	10	592008	63
505.50	KIT ANTI-INFORTUNISTICA 4 PCS	1	505503	58	593.00	TRIVELLINO PER LEGNO 5MM	10	593005	63
505.80	3 PAIA TAPPI AURICOLARI CE	10	505800	58	594.00	TRIVELLINO PER LEGNO 6MM	10	594002	63
505.83	5 PAIA TAPPI AUR.DOP.STRATO CE	10	505831	58	595.00	TRIVELLINO PER LEGNO 8MM	10	595009	63
505.86	1 PAIO TAPPI AUR.CORDONCINO CE	10	505862	58	597.00	TRIVELLINI PER LEGNO 2-3-4MM	10	597003	63
506.10	50 GUANTI M NITRILE HD CE	1	506104	59	598.00	LEVA-CHIODI 190MM	10	598000	64
506.11	50 GUANTI L NITRILE HD CE	1	506111	59	598.50	PENNA PER INCISIONI SU METALLO	5	598505	78
506.12	50 GUANTI XL NITRILE HD CE	1	506128	59	599.00	PISTOLA TERMOCOLLANTE 20W-7MM	1	599007	78
506.15	100 GUANTI M NITRILE CE	1	506159	59	599.20	PISTOLA TERMOCOLLANTE 40W-11MM	1	599205	78
506.16	100 GUANTI L NITRILE CE	1	506166	59	60.043	COLLARE RIDUZIONE 60X43MM	1	600437	84
506.17	100 GUANTI XL NITRILE CE	1	506173	59	60.046	COLLARE RIDUZIONE 60X46MM	1	600468	84
506.50	GINOCCHIERE IN GOMMA	1	506500	59	60.050	COLLARE RIDUZIONE 60X50MM	1	600505	84
506.60	ELMETTO PROTETTIVO CE	1	506609	59	60.053	COLLARE RIDUZIONE 60X53MM	1	600536	84
507.00	MISCELATORE 80X400MM	5	507002	60	60.054	COLLARE RIDUZIONE 60X54MM	1	600543	84
508.00	MISCELATORE 100X500MM	2	508009	60	60.056	COLLARE RIDUZIONE 60X56MM	1	600567	84
509.00	MISCELATORE 120X600MM	2	509006	60	600.00	12 STICK COLLA 7X100MM	10	600000	78
509.40	MISCELATORE 130X600MM	2	509402	60	600.20	12 STICK COLLA 11X100MM	10	600208	78
510.00	MISCELATORE 60X350MM	10	510002	60	601.00	GRAFFATRICE	1	601007	65
511.00	MISCELATORE 60X400MM	5	511009	60	604.00	GRAFFATRICE IN METALLO REG.LE	1	604008	65
512.00	MISCELATORE 80X400MM	5	512006	60	607.30	5000 PUNTI 6MM	5	607306	65
513.00	MISCELATORE 100X600MM	2	513003	60	607.35	1000 PUNTI 6MM	10	607351	65
514.00	MISCELATORE 120X600MM	2	514000	60	607.40	5000 PUNTI 8MM	5	607405	65
514.10	MISCELATORE 125X600MM D.ELICA	2	514109	60	607.45	1000 PUNTI 8MM	10	607450	65
550.00	FLESSIBILE 90CM	1	550008	77	607.50	5000 PUNTI 10MM	5	607504	65
550.06	MANDRINO 6MM PER FLESSIBILE	1	550060	77	607.55	1000 PUNTI 10MM	10	607559	65
555.00	FLESSIBILE 130CM	1	555003	77	607.60	5000 PUNTI 12MM	5	607603	65
555.08	MANDRINO 8MM PER FLESSIBILE	1	555089	77	607.65	1000 PUNTI 12MM	10	607658	65
560.00	FLESSIBILE 130CM PROFESSIONALE	1	560007	77	607.70	5000 PUNTI 14MM	5	607702	65
565.00	RACCOGLI POLVERE 4/10MM	10	565002	85	607.75	1000 PUNTI 14MM	10	607757	65

INDICE NUMERICO: ARTICOLI, QUANTITÀ E CODICI A BARRE

Anteporre al codice EAN il prefisso 8011017

ref.	descrizione	☐	ean	pag.	ref.	descrizione	☐	ean	pag.
611.10	FLESSOMETRO 3M - NASTRO 16MM	12	611105	66	687.00	3 LAME B.& D. D.GROSSI CV	10	687001	69
611.20	FLESSOMETRO 5M - NASTRO 19MM	6	611204	66	688.00	3 LAME B.& D. D.MEDI CV	10	688008	69
611.30	FLESSOMETRO 8M - NASTRO 25MM	4	611303	66	689.00	3 LAME B.& D. D.FINI CV	10	689005	69
611.65	24 FLESSOMETRI 5M	1	611655	66	689.10	3 LAME B.& D. D.GROSSI CV RET	10	689104	69
620.00	3 BOCCOLE ARRESTO 6-8-10MM	10	620008	68	689.20	3 LAME B.& D. D.MEDI CV RET	10	689203	69
620.10	BOCCOLA ARRESTO 12MM	10	620107	68	689.50	3 LAME B.& D. D.MEDI CV 100MM	10	689500	69
620.20	BOCCOLA ARRESTO 14MM	10	620206	68	694.00	3 LAME BOSCH D.GROSSI HSS	10	694009	70
624.00	PIALLA IN LEGNO 36MM	1	624006	64	695.00	3 LAME BOSCH D.MEDI HSS	10	695006	70
624.10	LAMA ACCIAIO 36MM PER 624.00	1	624105	64	696.00	3 LAME BOSCH D.FINI HSS	10	696003	70
625.00	PIALLA IN LEGNO 45MM	1	625003	64	696.50	3 LAME BOSCH D.MEDI HSS 80MM	10	696508	70
625.10	LAMA ACCIAIO 45MM PER 625.00	1	625102	64	697.00	3 LAME BOSCH D.GROSSI CV	10	697000	70
626.00	PIALLA IN LEGNO 48MM	1	626000	64	698.00	3 LAME BOSCH D.MEDI CV	10	698007	70
626.10	LAMA ACCIAIO 48MM PER 626.00	1	626109	64	699.00	3 LAME BOSCH D.FINI CV	10	699004	70
628.00	PIALLA LEGNO SPONDERUOLA 24MM	1	628004	64	699.10	3 LAME BOSCH D.GROSSI CV RET	10	699103	70
628.10	LAMA ACCIAIO 24MM PER 628.00	1	628103	64	699.20	3 LAME BOSCH D.MEDI CV RET	10	699202	70
629.00	PIALLA LEGNO SPONDERUOLA 27MM	1	629001	64	699.50	3 LAME BOSCH D.MEDI CV 100MM	10	699509	70
629.10	LAMA ACCIAIO 27MM PER 629.00	1	629100	64	699.60	2 LAME BOSCH D.MEDI CV 220MM	10	087399	70
629.85	2 LAME PIALLETTO 75,5X5,5X1,1	5	629858	64	704.00	3 LAME BOSCH D.GROSSI HSS	10	704005	71
629.87	2 LAME PIALLETTO 80,5X5,9X1,1	5	629872	64	705.00	3 LAME BOSCH D.MEDI HSS	10	705002	71
629.89	2 LAME PIALLETTO 82,0X5,5X1,1	5	629896	64	706.00	3 LAME BOSCH D.FINI HSS	10	706009	71
629.93	2 LAME PIALLETTO 102X5,5X1,1	5	629933	64	707.00	3 LAME BOSCH D.GROSSI CV	10	707006	71
630.03	PUNTA LEGNO 3MM	10	630038	88	708.00	3 LAME BOSCH D.MEDI CV	10	708003	71
630.04	PUNTA LEGNO 4MM	10	630045	88	714.00	3 LAME MAKITA D.GROSSI HSS	10	714004	71
630.05	PUNTA LEGNO 5MM	10	630052	88	715.00	3 LAME MAKITA D.MEDI HSS	10	715001	71
630.06	PUNTA LEGNO 6MM	10	630069	88	716.00	3 LAME MAKITA D.FINI HSS	10	716008	71
630.07	PUNTA LEGNO 7MM	10	630076	88	717.00	3 LAME MAKITA D.GROSSI CV	10	717005	71
630.08	PUNTA LEGNO 8MM	10	630083	88	718.00	3 LAME MAKITA D.MEDI CV	10	718002	71
630.09	PUNTA LEGNO 9MM	10	630090	88	719.00	3 LAME MAKITA D.FINI CV	10	719009	71
630.10	PUNTA LEGNO 10MM	10	630106	88	720.00	3 LAME B.& D. D.MEDI CV SAGOM.	10	720005	69
630.11	PUNTA LEGNO 11MM	10	630113	88	720.50	2 LAME B&D D.DENT. CV 115MM	5	720500	69
630.12	PUNTA LEGNO 12MM	10	630120	88	720.90	KIT 10 LAME B&D ASSORTITE	3	720906	69
630.13	PUNTA LEGNO 13MM	10	630137	88	721.00	3 LAME BOSCH D.MEDI CV SAGOM.	10	721002	70
630.14	PUNTA LEGNO 14MM	10	630144	88	721.50	2 LAME BOSCH D.DENT. CV 115MM	5	721507	70
649.00	MATITA PER FALEGNAME 180MM	144	009407	67	721.90	KIT 10 LAME BOSCH ASSORTITE	3	721903	70
649.06	6 MATITE PER FALEGNAME 180MM	5	649061	67	722.00	3 LAME MAKITA D.MEDI CV SAGOM.	10	722009	71
650.00	MORSETTO PER SPINATURA	1	650005	67	724.00	LAMA B.& D. METALLO DURO	5	724003	69
655.00	100 TASSELLI LEGNO 6X30MM	10	655000	67	725.00	LAMA BOSCH METALLO DURO	5	725000	70
655.05	1000 TASSELLI LEGNO 6X30MM	1	655055	67	728.00	PUNTA PER VETRO 3MM	5	728001	85
660.00	60 TASSELLI LEGNO 8X35MM	10	660004	67	728.10	PUNTA PER VETRO 4MM	5	728100	85
660.05	1000 TASSELLI LEGNO 8X35MM	1	660059	67	728.20	PUNTA PER VETRO 5MM	5	728209	85
665.00	40 TASSELLI LEGNO 10X40MM	10	665009	67	728.30	PUNTA PER VETRO 6MM	5	728308	85
665.05	1000 TASSELLI LEGNO 10X40MM	1	665054	67	728.40	PUNTA PER VETRO 8MM	5	728407	85
666.00	30 TASSELLI LEGNO 12X40MM	10	666006	67	728.50	PUNTA PER VETRO 10MM	5	728506	85
666.05	500 TASSELLI LEGNO 12X40MM	1	666051	67	728.60	PUNTA PER VETRO 12MM	5	728605	85
668.00	100 ASTE LEGNO 6X1000MM	1	668000	67	730.00	SEGA A TAZZA 25/62MM 25MM	10	730004	72
668.10	100 ASTE LEGNO 8X1000MM	1	668109	67	732.00	SEGA A TAZZA 25/62MM 50MM	10	732008	72
668.20	100 ASTE LEGNO 10X1000MM	1	668208	67	735.00	SEGA A TAZZA 60/95MM 40MM	5	735009	72
668.30	50 ASTE LEGNO 12X1000MM	1	668307	67	740.00	SEGA CIRC. 125X20 D. 24 C.V.	5	740003	74
668.40	40 ASTE LEGNO 14X1000MM	1	668406	67	745.00	SEGA CIRC. 125X20 D. 80 C.V.	5	745008	74
668.50	40 ASTE LEGNO 16X1000MM	1	668505	67	750.00	SEGA CIRC. 150X20 D. 24 C.V.	5	750002	74
669.00	50 LAMELLE LEGNO TIPO 0	10	669007	68	755.00	SEGA CIRC. 150X20 D. 80 C.V.	5	755007	74
669.05	1000 LAMELLE LEGNO TIPO 0	1	669052	68	756.02	SEGA CIRC. 125X20 D. 18 M.DURO	1	756028	74
669.10	50 LAMELLE LEGNO TIPO 10	10	669106	68	756.06	SEGA CIRC. 140X20 D. 18 M.DURO	1	756066	74
669.15	1000 LAMELLE LEGNO TIPO 10	1	669151	68	756.10	SEGA CIRC. 150X20 D. 20 M.DURO	1	756103	74
669.20	50 LAMELLE LEGNO TIPO 20	10	669205	68	756.12	SEGA CIRC. 150X30 D. 36 M.DURO	1	756127	74
669.25	1000 LAMELLE LEGNO TIPO 20	1	669250	68	756.14	SEGA CIRC. 160X20 D. 24 M.DURO	1	756141	74
670.00	4 SPINE A CENTRARE 6MM	10	670003	68	756.16	SEGA CIRC. 160X20 D. 36 M.DURO	1	756165	74
675.00	4 SPINE A CENTRARE 8MM	10	675008	68	756.18	SEGA CIRC. 170X30 D. 18 M.DURO	1	756189	74
680.00	4 SPINE A CENTRARE 10MM	10	680002	68	756.20	SEGA CIRC. 170X30 D. 36 M.DURO	1	756202	74
680.10	4 SPINE A CENTRARE 12MM	10	680101	68	756.22	SEGA CIRC. 180X30 D. 22 M.DURO	1	756226	74
680.20	2 SPINE A CENTRARE 14MM	10	680200	68	756.24	SEGA CIRC. 180X30 D. 36 M.DURO	1	756240	74
681.00	KIT ASSEMBLAGGIO 6MM	5	681009	68	756.26	SEGA CIRC. 180X30 D. 52 M.DURO	1	756264	74
682.00	KIT ASSEMBLAGGIO 8MM	5	682006	68	756.28	SEGA CIRC. 190X30 D. 30 M.DURO	1	756288	74
683.00	KIT ASSEMBLAGGIO 10MM	5	683003	68	756.30	SEGA CIRC. 190X30 D. 42 M.DURO	1	756301	74
684.00	3 LAME B.& D. D.GROSSI HSS	10	684000	69	756.32	SEGA CIRC. 200X30 D. 42 M.DURO	1	756325	74
685.00	3 LAME B.& D. D.MEDI HSS	10	685007	69	756.34	SEGA CIRC. 200X30 D. 60 M.DURO	1	756349	74
686.00	3 LAME B.& D. D.FINI HSS	10	686004	69	756.36	SEGA CIRC. 210X30 D. 20 M.DURO	1	756363	74
686.50	3 LAME B.& D. D.MEDI HSS 80MM	10	686509	69	756.38	SEGA CIRC. 210X30 D. 30 M.DURO	1	756387	74

INDICE NUMERICO: ARTICOLI, QUANTITÀ E CODICI A BARRE

Anteporre al codice EAN il prefisso 8011017

ref.	descrizione	☐	ean	pag.	ref.	descrizione	☐	ean	pag.
756.40	SEGA CIRC. 210X30 D. 42 M.DURO	1	756400	74	946.00	8 CHIAVI VITI ESAGONALI	10	946009	79
756.42	SEGA CIRC. 230X30 D. 20 M.DURO	1	756424	74	946.50	10 CHIAVI VITI ESAGONALI	10	946504	79
756.44	SEGA CIRC. 230X30 D. 34 M.DURO	1	756448	74	947.00	8 CHIAVI VITI TORX	10	947006	79
756.46	SEGA CIRC. 230X30 D. 40 M.DURO	1	756462	74	948.00	STRETTOIO PER FALEGNAME 150MM	6	948003	80
756.48	SEGA CIRC. 250X30 D. 24 M.DURO	1	756486	74	948.10	STRETTOIO PER FALEGNAME 200MM	6	948102	80
756.50	SEGA CIRC. 250X30 D. 48 M.DURO	1	756509	74	948.20	STRETTOIO PER FALEGNAME 250MM	6	948201	80
756.52	SEGA CIRC. 250X30 D. 60 M.DURO	1	756523	74	948.30	STRETTOIO PER FALEGNAME 300MM	6	948300	80
756.54	SEGA CIRC. 300X30 D. 48 M.DURO	1	756547	74	948.40	STRETTOIO PER FALEGNAME 400MM	4	948409	80
756.56	SEGA CIRC. 300X30 D. 72 M.DURO	1	756561	74	948.50	STRETTOIO PER FALEGNAME 500MM	4	948508	80
756.58	SEGA CIRC. 300X30 D. 96 M.DURO	1	756585	74	948.60	STRETTOIO PER FALEGNAME 600MM	4	948607	80
756.60	SEGA CIRC. 350X30 D. 84 M.DURO	1	756608	74	948.65	STRETTOIO PER FALEGNAME 700MM	2	948652	80
756.62	SEGA CIRC. 350X30 D.108 M.DURO	1	756622	74	948.70	STRETTOIO PER FALEGNAME 800MM	2	948706	80
760.00	MANDRINO AUTOSERRANTE 10MM	1	760001	75	948.80	STRETTOIO PER FALEGNAME 1000MM	2	948805	80
762.00	MANDRINO AUTOSERRANTE 10MM	1	762005	75	948.82	STRETTOIO PER FALEGNAME 1200MM	2	948829	80
764.00	MANDRINO AUTOSERRANTE 13MM	1	764009	75	948.84	STRETTOIO PER FALEGNAME 1500MM	2	948843	80
766.00	MANDRINO AUTOSERRANTE 10MM	1	766003	75	948.86	STRETTOIO PER FALEGNAME 2000MM	2	948867	80
768.00	MANDRINO AUTOSERRANTE 13MM	1	768007	75	948.88	STRETTOIO PER FALEGNAME 2500MM	2	948881	80
773.00	MANDRINO SENZA CHIAVE 10MM	1	773001	75	948.90	STRETTOIO PER FALEGNAME 3000MM	2	948904	80
774.00	MANDRINO SENZA CHIAVE 10MM	1	774008	75	948.93	STRETTOIO AUTOBLOCCANTE 150MM	4	948935	80
774.50	MANDRINO SENZA CHIAVE 13MM	1	774503	75	948.95	STRETTOIO AUTOBLOCCANTE 300MM	4	948959	80
775.00	MANDRINO SENZA CHIAVE 10MM	1	775005	75	948.97	STRETTOIO AUTOBLOCCANTE 450MM	4	948973	80
775.50	MANDRINO SENZA CHIAVE 13MM	1	775500	75	949.00	MORSETTO SERRAGGIO "C" 80X65	1	949000	80
775.51	MANDRINO SENZA CHIAVE 13MM-SDS	1	775517	75	949.10	MORSETTO SERRAGGIO "C" 105X75	1	949109	80
775.60	MANDRINO SENZA CHIAVE 13MM	1	775609	75	949.20	MORSETTO SERRAGGIO "C" 160X75	1	949208	80
775.61	MANDRINO SENZA CHIAVE 13MM-SDS	1	775616	75	949.50	MORSETTO REGOLAZ. RAPIDA 50MM	5	949505	81
780.00	MANDRINO CREMAGLIERA 10MM	1	780009	76	949.60	MORSETTO REGOLAZ. RAPIDA 75MM	5	949604	81
781.00	MANDRINO CREMAGLIERA 13MM	1	781006	76	949.70	MORSETTO REGOLAZ. RAPIDA 100MM	5	949703	81
783.00	MANDRINO CREMAGLIERA 10MM	1	783000	76	951.00	MORSETTO 25MM	10	951003	81
784.00	MANDRINO CREMAGLIERA 13MM	1	784007	76	952.00	MORSETTO 50MM	10	952000	81
786.00	MANDRINO CREMAGLIERA 10MM	1	786001	76	953.00	MORSETTO 75MM	10	953007	81
787.00	MANDRINO CREMAGLIERA 13MM	1	787008	76	954.00	MORSA DA BANCO 70MM	1	954004	81
787.01	MANDRINO CREMAGLIERA 13MM-SDS	1	787015	76	955.00	MORSETTO AD ANGOLO 90°	1	955001	81
788.00	MANDRINO CREMAGLIERA 10MM-HEX	1	788005	76	956.00	MORSETTO AD ANGOLO PER CORNICI	5	956008	81
788.50	MANDRINO AVVITATORE 6,5MM-HEX	5	788500	76	957.00	MORSETTO SERRAGGIO A NASTRO 4M	1	957005	82
789.00	RACCORDO PER MANDRINO 1/2X20	5	789002	77	957.50	MORSETTO A CRICCO 50MM	5	957500	82
789.10	VITE M6 SINISTRA PER MANDRINI	1	789101	77	957.70	MORSETTO A CRICCO 70MM	5	957708	82
789.50	RACCORDO M3/8-M1/2	1	789507	77	958.00	4 MINI MORSETTI 18MM	10	958002	82
789.60	RACCORDO M3/8-M3/8	1	789606	77	958.05	MORSETTO A MOLLA 30MM	10	958057	82
789.70	RACCORDO M1/2-F3/8	1	789705	77	958.07	MORSETTO A MOLLA 40MM	10	958071	82
790.00	CHIAVE PER MANDRINO 10MM B&D	10	790008	77	958.10	MORSETTO A MOLLA 60MM	10	958101	82
791.00	CHIAVE PER MANDRINO 13MM B&D	10	791005	77	958.14	MORSETTO A MOLLA 70MM	10	958149	82
792.00	CHIAVE PER MANDRINO 13MM	10	792002	77	960.00	SUPPORTO ORIENTAB.TRAPANO 43MM	1	960005	83
793.00	CHIAVE PER MANDRINO 16MM	5	793009	77	965.00	TORNIO DA BANCO 43MM	1	965000	83
794.00	CHIAVE UNIVERSALE PER MANDRINI	5	794006	77	970.00	SUPPORTO PER FRESARE 43MM	1	970004	83
800.00	UTENSILE CONICO HSS 3/14MM	1	800004	11	972.00	GUIDA REGOLABILE TRAPANO 43MM	1	972008	83
805.00	UTENSILE CONICO HSS 6/20MM	1	805009	11	A96/C49	MOLE ABRASIVE	1		36
810.00	UTENSILE CONICO HSS 8/30MM	1	810003	11	C48/C48	BASTONCINI RAVVIVAMOLE	8		37
820.00	UTENSILE CONICO HSS 20/40MM	1	820002	11	DG/DG	PIETRE DOPPIA GRANA	4		37
825.00	UTENSILE CONICO HSS 20/50MM	1	825007	11	LQU/LTR	LIME ABRASIVE	10		37
825.50	FRESA A GRADINI HSS 4/12MM	1	825502	11	MA/MN	MOLE/GAMBO	10		32
826.00	FRESA A GRADINI HSS 4/20MM	1	826004	11	ESPO.S1	ESPO DA BANCO SPAZZOLE 134 PZ	1	087450	55
828.00	FRESA A GRADINI HSS 6/30MM	1	828008	11	ESPO.S2	ESPO DA BANCO SPAZZOLE 94 PZ	1	087702	55
829.00	FRESA A GRADINI HSS 3,5/40MM	1	829005	11	FC.01	FOGLI CARTA 230X280 GR. 40	100	083346	22
835.00	FRESA CONICA HSS 0/25MM	5	835006	12	FC.03	FOGLI CARTA 230X280 GR. 60	100	083353	22
835.50	FRESA CONICA HSS 6/32MM	1	835501	12	FC.04	FOGLI CARTA 230X280 GR. 80	100	083360	22
835.60	FRESA CONICA HSS 6/45MM	1	835600	12	FC.05	FOGLI CARTA 230X280 GR.100	100	083377	22
840.00	SVASATORE HSS 12MM	5	840000	12	FC.06	FOGLI CARTA 230X280 GR.120	100	083384	22
845.00	SVASATORE HSS 16MM	5	845005	12	FC.07	FOGLI CARTA 230X280 GR.150	100	083391	22
850.00	SVASATORE HSS 20MM	5	850009	12	FC.08	FOGLI CARTA 230X280 GR.180	100	083407	22
880.00	MOLA AD ACQUA 100X20X16MM	1	880006	78	RC.01	ROTOLO CARTA 120X50YDS GR. 40	1	085159	23
882.00	MOLA 100X20X16 PER ART.880.00	1	882000	78	RC.03	ROTOLO CARTA 120X50YDS GR. 60	1	085166	23
890.00	POMPA PER LIQUIDI	5	890005	78	RC.04	ROTOLO CARTA 120X50YDS GR. 80	1	085173	23
921.00	TRAPANO A MANO 6MM	5	921006	79	RC.05	ROTOLO CARTA 120X50YDS GR.100	1	085180	23
924.00	TRAPANO A MANO 8MM	1	924007	79	RC.06	ROTOLO CARTA 120X50YDS GR.120	1	085197	23
928.00	TRAPANO A MANO 13MM	1	928005	79	RC.07	ROTOLO CARTA 120X50YDS GR.150	1	085203	23
930.00	MANDRINO PER TRAPANO MANO 6MM	1	930008	79	RC.08	ROTOLO CARTA 120X50YDS GR.180	1	085210	23
932.00	MANDRINO 8MM	1	932002	79	RC.09	ROTOLO CARTA 120X50YDS GR.240	1	085227	23
936.00	MANDRINO PER TRAPANO MANO 13MM	1	936000	79	RG/RG	RUOTE LAMELLARI	10		29

INDICE NUMERICO: ARTICOLI, QUANTITÀ E CODICI A BARRE

Anteporre al codice EAN il prefisso 8011017

ref.	descrizione	☐	ean	pag.	ref.	descrizione	☐	ean	pag.
T.01	FOGLI TELA 230X280 GR. 30	50	085869	23	WSC.001	FOGLI CARTA IMPERM.LE GR.100	100	085982	22
T.03	FOGLI TELA 230X280 GR. 40	50	085876	23	WSC.002	FOGLI CARTA IMPERM.LE GR.120	100	085999	22
T.04	FOGLI TELA 230X280 GR. 60	50	085883	23	WSC.003	FOGLI CARTA IMPERM.LE GR.150	100	086002	22
T.05	FOGLI TELA 230X280 GR. 80	50	085890	23	WSC.004	FOGLI CARTA IMPERM.LE GR.180	100	086019	22
T.06	FOGLI TELA 230X280 GR.100	50	085906	23	WSC.005	FOGLI CARTA IMPERM.LE GR.220	100	086026	22
T.07	FOGLI TELA 230X280 GR.120	50	085913	23	WSC.006	FOGLI CARTA IMPERM.LE GR.240	100	086033	22
T.08	FOGLI TELA 230X280 GR.150	50	085920	23	WSC.007	FOGLI CARTA IMPERM.LE GR.280	100	086040	22
T.09	FOGLI TELA 230X280 GR.180	50	085937	23	WSC.008	FOGLI CARTA IMPERM.LE GR.320	100	086057	22
T.10	FOGLI TELA 230X280 GR.220	50	085944	23	WSC.009	FOGLI CARTA IMPERM.LE GR.360	100	086064	22
T.11	FOGLI TELA 230X280 GR.240	50	085951	23	WSC.010	FOGLI CARTA IMPERM.LE GR.400	100	086071	22
T.12	FOGLI TELA 230X280 GR.320	50	085968	23	WSC.011	FOGLI CARTA IMPERM.LE GR.500	100	086088	22
T.13	FOGLI TELA 230X280 GR.400	50	085975	23	WSC.012	FOGLI CARTA IMPERM.LE GR.600	100	086095	22
M.1010	2 FRESE ACCIAIO SFERA 1,4MM	5	090009	90	M.2235	2 MOLE RUBINO CON. ROV. 8X6MM	5	090511	93
M.1020	2 FRESE ACCIAIO SFERA 2,3MM	5	090016	90	M.2410	2 MOLE CARBURO CON. ARR.3X8MM	5	090528	94
M.1030	FRESA ACCIAIO SFERA 4,0MM	5	090092	90	M.2420	2 MOLE CARBURO CON. ARR.5X10MM	5	090535	94
M.1050	FRESA ACCIAIO SFERA 6,0MM	5	090108	90	M.2435	2 MOLE CARBURO SFERA 4MM	5	090542	94
M.1065	FRESA ACCIAIO OVALE 7,8MM	5	092928	90	M.2450	2 MOLE CARBURO CON. ROV. 8X6MM	5	090559	94
M.1070	2 FRESE ACCIAIO CILIND. 1,4MM	5	090023	90	M.2465	2 MOLE CARBURO SEMISF. 6X10MM	5	090566	94
M.1080	2 FRESE ACCIAIO CILIND. 2,3MM	5	090030	90	M.2480	2 MOLE CARBURO FIAMMA 5X10MM	5	090573	94
M.1100	FRESA ACCIAIO CILINDRICA 6,0MM	5	090115	90	M.2510	2 MOLE RUBINO LENTICOLARE 22MM	5	090580	94
M.1105	FRESA ACCIAIO CILINDRICA 7,8MM	5	092935	90	M.2520	2 MOLE CARBURO LENTICOLARE 22	5	090597	94
M.1120	2 FRESE ACCIAIO CONO RO. 1,4MM	5	090047	90	M.2610	2 MOLE RUBINO RUOTINA 22MM	5	090603	94
M.1130	2 FRESE ACCIAIO CONO RO. 2,3MM	5	090054	90	M.2620	2 MOLE CARBURO RUOTINA 22MM	5	090610	94
M.1140	FRESA ACCIAIO CONO ROV. 4,0MM	5	090122	90	M.2630	2 MOLE ABR. BIANCO RUOTINA 22	5	090627	94
M.1170	2 FRESE ACCIAIO FIAMMA 2,3MM	5	090061	90	M.2640	2 MOLE ABR. MARRONE RUOTINA 22	5	090634	94
M.1190	FRESA ACCIAIO CON.FIAMMA 4,0MM	5	090139	90	M.2710	2 MOLE RUBINO AF.CATENE 4,0X19	5	090641	95
M.1240	FRESA ACCIAIO CONICA 6,0MM	5	090146	90	M.2715	2 MOLE RUBINO AF.CATENE 4,8X19	5	090658	95
M.1270	2 FRESE ACCIAIO PUNTA 2,3MM	5	090078	90	M.2720	2 MOLE RUBINO AF.CATENE 5,6X21	5	090665	95
M.1310	FRESA ACCIAIO PUNTA 6,0MM	5	090153	90	M.2910	RAVVIVAMOLE D.GRANA 16X12X65MM	5	090672	95
M.1340	2 FRESE ACCIAIO RUOTA 2,3MM	5	090085	90	M.3020	RUOTA LAMELLARE 20X05MM GR. 80	5	090689	96
M.1370	FRESA ACCIAIO RUOTA 6,0MM	5	090160	90	M.3030	RUOTA LAMELLARE 30X10MM GR. 80	5	090696	96
M.1375	FRESA ACCIAIO RUOTA 9,5MM	5	092942	90	M.3210	PLATORELLO E 6 DISCHI ABRASIVI	5	090702	96
M.1510	FRESA CARBURO SFERA 1,8MM	5	090177	91	M.3220	10 DISCHI ADESIVI 20MM GR. 100	5	090719	96
M.1520	FRESA CARBURO SFERA 3MM	5	090184	91	M.3230	10 DISCHI ADESIVI 20MM GR. 220	5	090726	96
M.1540	FRESA CARBURO CILINDRICA 1,8MM	5	090191	91	M.3610	SMERIGLIATORE ESP.NE 13X13MM	5	090733	96
M.1550	FRESA CARBURO CILINDRICA 3MM	5	090207	91	M.3620	12 NASTRI ABRASIVI 13MM GR. 60	5	090740	96
M.1560	FRESA CARBURO CONICA 1,8MM	5	090214	91	M.3630	12 NASTRI ABRASIVI 13MM GR.120	5	090757	96
M.1570	FRESA CARBURO CONICA 3MM	5	090221	91	M.3640	SMERIGLIATORE ESP.NE 9,5X13MM	5	092959	97
M.1580	FRESA CARBURO FIAMMA 3MM	5	090238	91	M.3650	12 NASTRI ABRA.VI 9,5MM GR. 60	5	092966	97
M.1710	FRESA HSS PROF. CONVESSI 3MM	2	090320	91	M.3660	12 NASTRI ABRA.VI 9,5MM GR.120	5	092973	97
M.1720	FRESA HSS PROF. CONCAVI 4MM	2	090337	91	M.3670	SMERIGLIATORE ESP.NE 6,3X13MM	5	092980	97
M.1750	FRESA HSS SCAN. DIRITTE 3MM	2	090344	91	M.3680	12 NASTRI ABRA.VI 6,3MM GR. 60	5	092997	97
M.1770	FRESA HSS SCANALATURE V 6,4MM	2	090351	91	M.3690	12 NASTRI ABRA.VI 6,3MM GR.120	5	093000	97
M.1905	PUNTA DIAMANTE SFERA 1,0MM	5	090245	92	M.4005	SPAZZOLA ACCIAIO PENNELLO 5MM	5	090764	98
M.1910	PUNTA DIAMANTE SFERA 1,4MM	5	090252	92	M.4010	SPAZZOLA ACCIAIO TAZZA 12MM	5	090771	98
M.1915	PUNTA DIAMANTE SFERA 1,8MM	5	090269	92	M.4015	SPAZZOLA ACCIAIO CIRCOLARE 21	5	090788	98
M.1925	PUNTA DIAMANTE CILINDRICA 1,5M	5	090276	92	M.4020	3 SPAZZOLE ACCIAIO ASSORTITE	5	090795	98
M.1935	FRESA DIAMANTE CILINDRICA 3,2M	5	090283	92	M.4055	SPAZZOLA OTTONE PENNELLO 5MM	5	090801	98
M.1950	PUNTA DIAMANTE FIAMMA 1,6MM	5	090290	92	M.4060	SPAZZOLA OTTONE TAZZA 12MM	5	090818	98
M.1970	PUNTA DIAMANTE PUNTA 2,8MM	5	090306	92	M.4065	SPAZZOLA OTTONE CIRCOLARE 21MM	5	090825	98
M.1980	FRESA DIAMANTE DISCO 5MM	5	090313	92	M.4070	3 SPAZZOLE OTTONE ASSORTITE	5	090832	98
M.2010	2 MOLE RUBINO CILIND. 3X8MM	5	090368	93	M.4105	SPAZZOLA SETOLA PENNELLO 5MM	5	090849	98
M.2025	2 MOLE RUBINO CILIND. 5X10MM	5	090375	93	M.4110	SPAZZOLA SETOLA TAZZA 12MM	5	090856	98
M.2040	2 MOLE RUBINO CILIND. 8X10MM	5	090382	93	M.4115	SPAZZOLA SETOLA CIRCOLARE 21MM	5	090863	98
M.2055	2 MOLE RUBINO CILIND. 10X12MM	5	090399	93	M.4120	3 SPAZZOLE SETOLA ASSORTITE	5	090870	98
M.2070	2 MOLE RUBINO CILIND.12X15MM	5	090405	93	M.4155	SPAZZOLA NYLON PENNELLO 5MM	5	090887	98
M.2085	2 MOLE RUBINO CONICA 3X8MM	5	090412	93	M.4160	SPAZZOLA NYLON TAZZA 12MM	5	090894	98
M.2100	2 MOLE RUBINO CONICA 5X10MM	5	090429	93	M.4165	SPAZZOLA NYLON CIRCOLARE 21MM	5	090900	98
M.2115	2 MOLE RUBINO CONICA 8X12MM	5	090436	93	M.4170	3 SPAZZOLE NYLON ASSORTITE	5	090917	98
M.2130	2 MOLE RUBINO OGIVA 6X10MM	5	090443	93	M.4305	TAMPONE SILICONE DISCO 12MM	5	090924	99
M.2145	2 MOLE RUBINO OGIVA 10X20MM	5	090450	93	M.4310	TAMPONE SILICONE LENTICOL.12MM	5	090931	99
M.2160	2 MOLE RUBINO SFERA 6MM	5	090467	93	M.4505	PUNTA IN GOMMA BLU FIAMMA 6MM	5	090948	99
M.2175	2 MOLE RUBINO SFERA 10MM	5	090474	93	M.4510	PUNTA IN GOMMA BLU OGIVA 5MM	5	090955	99
M.2190	2 MOLE RUBINO CIL.CON. 6X12MM	5	090481	93	M.4515	PUNTA IN GOMMA BLU CILIND. 6MM	5	090962	99
M.2205	2 MOLE RUBINO CIL.CON. 8X15MM	5	090498	93	M.4595	2 DISCHI GOMMA MARRONE 22X3MM	5	090979	99
M.2220	2 MOLE RUBINO CIL.CON. 10X20MM	5	090504	93	M.4605	DISCO FELTRO CONO 11MM	5	090986	100

INDICE NUMERICO: ARTICOLI, QUANTITÀ E CODICI A BARRE

Anteporre al codice EAN il prefisso 8011017

ref.	descrizione	☐	ean	pag.	ref.	descrizione	☐	ean	pag.
M.4610	DISCO FELTRO CONO ROV.TO 14MM	5	090993	100	M.6220	PUNTA HSS RINFORZATA 2,0MM	5	091334	103
M.4615	DISCO FELTRO RUOTA 22MM	5	091006	100	M.8010	KIT 5 PINZE + GHIERA	2	093017	104
M.4680	KIT 3 FELTRI + ALBERINO +PASTA	5	091013	100	M.8020	KIT 4 PINZE + GHIERA DREMEL	2	093024	104
M.4810	DISCO COTONE MORBIDO 24MM	5	091020	100	M.8100	ALBERINO A VITE	5	091358	104
M.4820	DISCO FELTRO MORBIDO 21MM	5	091037	100	M.8110	ALBERINO A VITE RINFORZATO	5	091365	104
M.4830	DISCO CAMOSCIO 21MM	5	091044	100	M.8120	ALBERINO A PIRAMIDE	5	091372	104
M.4840	DISCO LAMELLE COTONE 21MM	5	091051	100	M.8210	KIT 10 ACCESSORI PER INCISIONI	2	093031	105
M.4850	DISCO SCOTCH FABRIC 22MM	5	091068	100	M.8230	KIT 10 ACCESSORI SMERIGLIATURA	2	093048	105
M.4905	PASTA PRE-LUCIDATURA ROSA UNIV	5	091075	100	M.8250	KIT 9 ACCESSORI LUCIDATURA	2	093055	105
M.4910	PASTA BIANCA LUCIDATURA FINALE	5	091082	100	M.8270	KIT 58 ACCESSORI PER TAGLIO	2	093062	105
M.4915	PASTA ABRASIVA ROSSA	5	091099	100	M.8305	CAVI PROLUNGA 5M	1	091402	104
M.5010	5 DISCHI TAGLIO 22X0,25MM SLIM	5	091105	101	M.8500	MINI ALBERO FLESSIBILE 80CM	1	091426	106
M.5030	10 DISCHI DA TAGLIO 22X0,6MM	5	091112	101	M.8550	MANDRINO AUTOSERRANTE 0,4/3,2	1	091389	106
M.5035	50 DISCHI DA TAGLIO 22X0,6MM	5	091129	101	M.8560	MANDRINO AUTO.0,4/3,2MM DREMEL	1	093376	106
M.5040	10 DISCHI TAGLIO 22X1MM RINF.	5	093680	101	M.8580	MANDRINO CREMAGLIERA 0,5/6MM	1	093598	106
M.5045	30 DISCHI TAGLIO 22X1MM RINF.	5	093697	101	M.8600	SUPPORTO ORIENTABILE 43+33MM	1	091433	107
M.5050	5 DISCHI TAGLIO 40X1MM RINF.	5	091136	101	M.8710	SUPPORTO PER MINI TRAPANI	1	093666	107
M.5130	2 DISCHI SGROSSATURA 32X2,2MM	5	091143	101	M.8750	MINI MORSA DA BANCO 50MM	1	093383	107
M.5405	MINI LAMA ACCIAIO 13MM	5	091150	102	M.8775	KIT SVITA E AVVITA 45 PCS	1	093574	107
M.5410	MINI LAMA ACCIAIO 19MM	5	091167	102	M.8790	KIT CUTTER PRECISIONE 18 PCS	1	093581	108
M.5415	MINI LAMA ACCIAIO 25MM	5	091174	102	M.8800	PIROGRAFO 30W + 2 PUNTE + SUPP	1	093550	108
M.5710	DISCO DIAMANTATO 22MM	5	091181	102	M.8815	PISTOLA TERMOCOLLANTE 30W-7MM	1	093703	109
M.5715	DISCO DIAMANTATO 30MM	5	093314	102	M.8820	PISTOLA TERMOCOLLANTE 20W-7MM	1	093529	109
M.5720	DISCO DIAMANTATO 40MM	5	093321	102	M.8822	12 STICK COLLA 7X100MM	10	600000	109
M.5750	DISCO DIAMANTATO SEGMENT. 22MM	5	093338	102	M.8845	PISTOLA TERMOCOLLANTE 60W-11MM	1	093710	109
M.5905	PUNTA TAGLIO LEGNO 3,2MM	5	093345	102	M.8857	12 STICK COLLA 11X100MM	10	600208	109
M.5910	PUNTA TAGLIO CARTONGESSO 3,2MM	5	093352	102	M.9000	TRASFORMATORE UNA VELOCITA'	1	091440	110
M.5915	PUNTA TAGLIO PIASTRELLE 3,2MM	5	093369	102	M.9100	MINI TRAPANO 30W	1	091464	112
M.6005	2 PUNTE HSS 0,5MM	5	091198	103	M.9150	KIT MINI TRAPANO 30W	1	091471	112
M.6006	2 PUNTE HSS 0,6MM	5	091204	103	M.9200	PENNA PER INCISIONI 6W	1	091488	110
M.6008	2 PUNTE HSS 0,8MM	5	091211	103	M.9220	PENNA PER INCISIONI 6W + TRASF	1	093628	111
M.6010	2 PUNTE HSS 1,0MM	5	091228	103	M.9250	KIT PER INCISIONI 6W	1	091495	111
M.6012	2 PUNTE HSS 1,2MM	5	091235	103	M.9300	MINI TRAPANO PRECISIONE 60W	1	093604	113
M.6015	2 PUNTE HSS 1,5MM	5	091242	103	M.9350	KIT MINI TRAPANO PRECIS. 60W	1	093611	113
M.6020	2 PUNTE HSS 2,0MM	5	091259	103	M.9500	MINI TRAPANO 130W	1	093116	114
M.6024	2 PUNTE HSS 2,4MM	5	091266	103	M.9550	KIT MINI TRAPANO 130W	1	093123	114
M.6030	2 PUNTE HSS 3,0MM	5	091273	103	M.9600	MINI TRAPANO 170W LCD	1	093413	115
M.6100	KIT 20 PUNTE HSS 0,3/1,6MM	2	091396	103	M.9650	KIT MINI TRAPANO 170W LCD	1	093420	115
M.6206	PUNTA HSS RINFORZATA 0,6MM	5	091280	103	M.BOX01	SCATOLA MODULARE PORTA ACC.RI	1	088228	106
M.6208	PUNTA HSS RINFORZATA 0,8MM	5	091297	103	ESPO.M3A	ESPO DA BANCO PG MINI 162 PZ	1	093727	116
M.6210	PUNTA HSS RINFORZATA 1,0MM	5	091303	103	ESPO.M3B	ESPO DA BANCO PG MINI 141 PZ	1	093734	116
M.6212	PUNTA HSS RINFORZATA 1,2MM	5	091310	103	ESPO.M3C	ESPO A PARETE PG MINI 709 PZ	1	093741	117
M.6215	PUNTA HSS RINFORZATA 1,5MM	5	091327	103					

CONDIZIONI GENERALI DI VENDITA

P.G. SRL DECLINA OGNI RESPONSABILITÀ PER DANNI PROVOCATI DAI PROPRI PRODOTTI IMPUTABILI AD UN ERRATO E/O INCAUTO E/O IMPROPRIO UTILIZZO DEGLI STESSI

Gli ordini sono assunti esclusivamente alle seguenti condizioni:

- Il trasporto viene effettuato tramite il mezzo da noi ritenuto più idoneo
- I termini di consegna non sono mai impegnativi e possono non essere rispettati, si escludono perciò risarcimenti per ritardi e/o consegne parziali e/o mancate consegne
- Reclami per contestazioni o differenze riscontrate devono pervenire entro otto giorni dalla data di ricezione della merce
- I pagamenti devono essere effettuati alle condizioni prestabilite
- Non si accettano sconti o arrotondamenti se non concordati preventivamente
- Per ritardato pagamento decorrono gli interessi di mora ed eventuali spese accessorie
- Si riconosce l'esclusiva competenza del Foro di Bologna per ogni controversia, anche se il contratto è stato stipulato in altra sede

È VIETATO OGNI UTILIZZO E/O RIPRODUZIONE ANCHE PARZIALE DEL TESTO, DEI DISEGNI E DELLE FOTOGRAFIE SENZA PREVIA AUTORIZZAZIONE DA PARTE DI P.G. SRL

LE FOTOGRAFIE, LE DESCRIZIONI, I DISEGNI E LE TABELLE SONO PURAMENTE INDICATIVE, P.G. SRL SI RISERVA IL DIRITTO DI EFFETTUARE MODIFICHE DEI PRODOTTI SENZA OBBLIGO DI PREAVVISO



P.G. Srl
via Piretti, 12/A
40012 Calderara di Reno (Bo) Italia
Tel. +39.051.727.102 - Fax +39.051.728.075
info@pgprofessional.it - www.pgprofessional.it
info@pgmini.it - www.pgmini.it